



Wireless-N Range Extender

User Manual



Version A1.0, June 19, 2012

Preface

This manual provides information related to the installation and operation of this Wireless-N Range Extender. The individual reading this manual is presumed to have a basic understanding of home networking terminology and concepts.

If you find the product to be inoperable or malfunctioning, please contact technical support for immediate service by email at homesupport@comtrend.com

For product updates, new product release, manual revision, or software upgrades, please visit our website at <http://www.comtrend.com>

Important Safety Instructions

With reference to unpacking, installation, use, and maintenance of your electronic Wireless-N Range Extender, the following basic guidelines are recommended:

Do not use or install this product near water, to avoid fire or shock hazard. For example, near a bathtub, kitchen sink or laundry tub, or near a swimming pool. Also, do not expose the equipment to rain or damp areas (e.g. a wet basement).

Copyright

Copyright© 2012 Comtrend Corporation. All rights reserved. The information contained herein is proprietary to Comtrend Corporation. No part of this document may be translated, transcribed, reproduced, in any form, or by any means without the prior written consent of Comtrend Corporation.

NOTE: This document is subject to change without notice.

Protect Our Environment



This symbol indicates that when the equipment has reached the end of its useful life, it must be taken to a recycling center and processed separate from domestic waste.

The cardboard box, the plastic contained in the packaging, and the parts that make up this router can be recycled in accordance with regionally established regulations. Never dispose of this electronic equipment along with your household waste; you may be subject to penalties or sanctions under the law. Instead, please be responsible and ask for disposal instructions from your local government.

Table of Contents

Chapter I: Product Information	1
1-1 Introduction and safety information	1
1-2 System Requirements	2
1-3 Package Contents.....	3
1-4 Get familiar with your new Wireless-N Range Extender	4
CHAPTER II: Repeater Mode	7
2-1 Repeater Mode Quick Installation Guide	7
2-1-1 Hardware WPS button setup	9
2-1-2 Web browser quick setup	11
2-2 Repeater mode Advanced Settings	15
2-2-1 Setup IP address	15
<i>Windows XP IP address setup:</i>	15
<i>Windows Vista/7 IP address setup:</i>	16
2-2-2 Connect to web configuration menu	18
2-2-3 Home	20
2-2-4 Wireless Setup – SSID	22
2-2-5 Wireless Setup – Encryption	24
2-2-6 Wireless Setup - WPS Setup	26
2-2-7 Advanced Settings	29
2-2-8 MAC Address Filtering	33
2-2-9 System Utility.....	39
2-2-10 Configuration	42
CHAPTER III: Client Mode	45
3-1 Client Mode Quick Installation Guide.....	45
3-1-1 Hardware WPS button setup	47
3-1-2 Web browser quick setup	50
3-2 Client Mode Advanced Settings	54
3-2-1 Setup IP address	54
<i>Windows XP IP address setup:</i>	54
<i>Windows Vista/7 IP address setup:</i>	55
3-2-2 Connect to web configuration menu	57
3-2-3 Home	58
3-2-4 Wireless Setup – SSID	59

3-2-5 Wireless Setup – Encryption	61
3-2-6 Wireless Setup - WPS Setup	62
3-2-7 Advanced Settings	65
3-2-8 System Utility.....	68
3-2-9 Configuration	71
CHAPTER IV: AP Mode.....	75
4-1 AP Mode Quick Installation Guide.....	75
4-1-1 Hardware WPS button setup	77
4-1-2 Web browser quick setup	79
4-2 AP mode Advanced Settings.....	84
4-2-1 Setup IP address	84
<i>Windows XP IP address setup:</i>	84
<i>Windows Vista/7 IP address setup:</i>	85
4-2-2 Connect to web configuration menu	87
4-2-3 Home	88
4-2-4 Wireless Setup – SSID	90
4-2-5 Wireless Setup – Encryption	92
4-2-6 Wireless Setup - WPS Setup	93
4-2-7 Advanced Settings	96
4-2-8 MAC Address Filtering	100
4-2-9 System Utility.....	106
4-2-10 Configuration	111
Chapter V: Appendix.....	114
5-1 Configuring TCP/IP on PC.....	114
<i>Windows XP IP address setup:</i>	114
<i>Windows Vista/Windows 7 IP address setup:</i>	116
5-2 Specification	118

Chapter I: Product Information

1-1 Introduction and safety information

The WAP-5883's compact design with built-in power provides excellent network performance to extend your Wi-Fi signal and wireless coverage.

Features of this Wireless-N Range Extender include:

- Easily extends the wireless signal inside your home or office
- Compact design while maintaining excellent network performance
- LED signal indicators to easily realize the best location placement to extend the WiFi signal for best wireless performance
- Supports Repeater mode, Access Point mode and Access Point Client mode
- Integrated hardware switch to change the operation mode quickly without logging into the web interface
- WPS (Wi-Fi Protected Setup) hardware button for easy installation and wireless security

1-2 System Requirements

- Wireless network card which is compatible with 802.11b/g/n wireless network standard
- Windows XP, Vista, or Windows 7 operating system
- CD-ROM drive
- At least 100MB of available disk space

1-3 Package Contents

Before you start to use this Wireless-N Range Extender, please check if there's anything missing in the package, and contact your place of purchase to claim for missing items:

- * 1 - CDROM (QIG/User Manual) (1)
- * 1 - Wireless-N Range Extender (2)
- * 1 - RJ-45 Cable (3)
- * 1 - Printed QIG (4)

1



2



3



4



1-4 Get familiar with your new Wireless-N Range Extender

Interface Descriptions

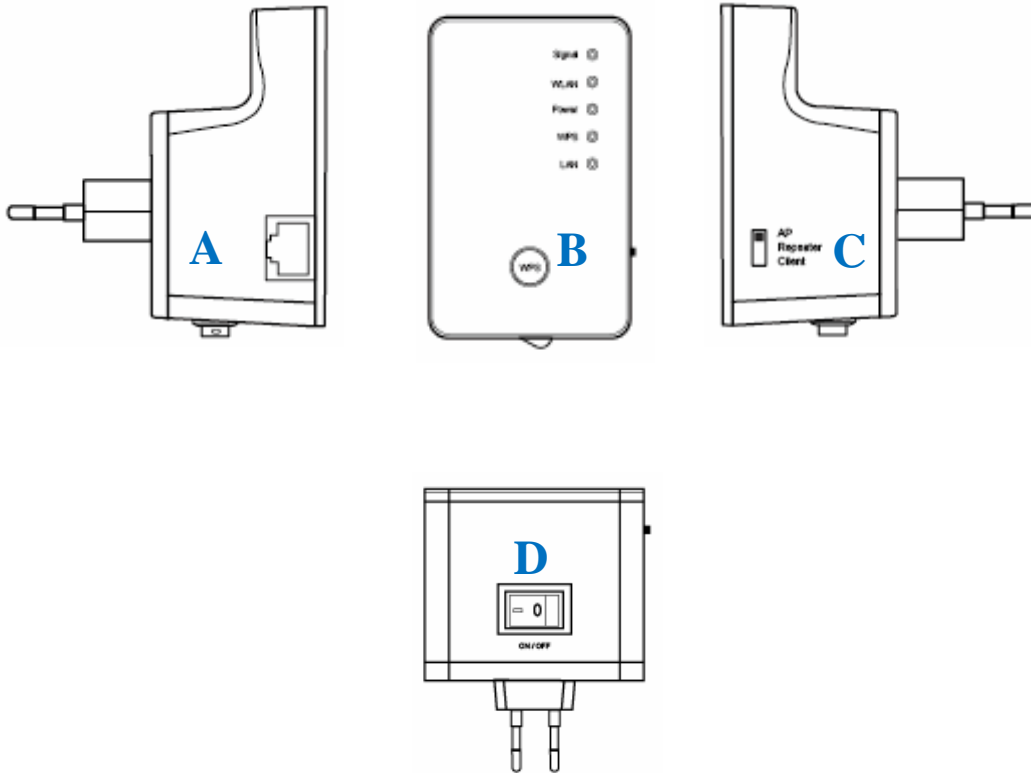

Item	Item Name	Description
A	LAN	10/100M Ethernet LAN Port with Auto-MDI/MDI-X. Connect to a computer, switch or hub for local network sharing.
B	Reset / WPS	Reset the Wireless-N Range Extender to factory default settings (clear all settings) or start the WPS function. Press this button and hold for 10 seconds to restore all settings to factory defaults, or press this button for less than 5 seconds to start the WPS function.
C	AP/Repeater/Client	Switch the button to change operating mode to Access Point, Repeater or Client mode.
D	ON/OFF	Power on/off switch.

LED Activity

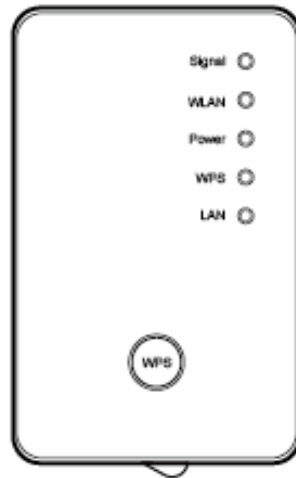

LED	Color	LED Status	Description
Signal	Amber	Steady ON	Good signal reception (signal strength 100%~50%).
		Blinking	Normal signal reception Slow blinking (Signal strength 50%~25%)
			Poor signal reception Quick blinking (Signal strength <25%)
		Off	Out of signal range or disconnected/ or in LED off mode.
WLAN	Green	Blinking	Connecting to wireless Router/or AP, wireless function is active (transferring or receiving data).
		Off	Wireless network is switched off/ or in LED off mode.
Power	Green	Steady ON	Power is turned on. <i>If the user selects to enable “LED OFF mode”, power LED On/Off depends on user’s selection, the user can select to leave only the power LED on or turn off all LEDs including the power LED.</i>
		Slow Blinking	Ready for “Reset to factory defaults”, power LED is blinking.

		Off	Power is turned off.
WPS	Green	Steady ON	When WPS connection is successful, stays on for 5 minutes.
		Blinking	WPS is in progress of waiting for another WPS device's connection
		Quick blinking	WPS error
		Off	NO WPS is in progress/ LED off mode
LAN	Green	Steady ON	LAN port is connected.
		Blinking	LAN port is active (transferring or receiving data).
		Off	LAN port is not connected/ or LED off mode.

CHAPTER II: Repeater Mode

This chapter will explain how to quickly install this Wireless-N Range Extender by using the quick setup method and explain each detailed setting on the web user interface while in repeater mode.

2-1 Repeater Mode Quick Installation Guide

For first time setup and installation, move this Wireless-N Range Extender close to the Wireless Broadband Router or Access point you wish to connect to. After installation is complete, move this Wireless-N Range Extender to the place you wish to permanently use it.

Switch mode selector to '**Repeater**'.

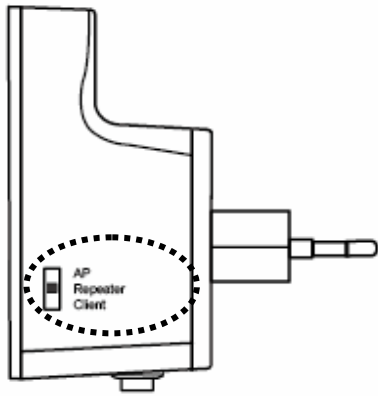

Plug this Wireless-N Range Extender into a power outlet on the wall, and flip the power switch to '**ON**' (1). You should see the '**Power**' LED light up in few seconds (2). If not, check if the power outlet you're using is working.

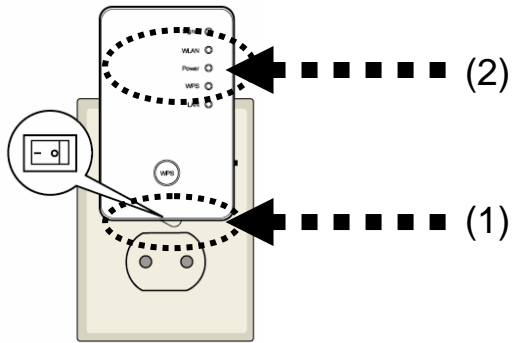

You can setup the wireless connection via the ‘Hardware WPS button’ or ‘Software web browser’.

If your broadband router or access point also supports a ‘WPS button’, we recommend you to use the WPS button to establish connection.

Using WPS button

- please go to section 2-1-1

Using Web browser

- please go to section 2-1-2

2-1-1 Hardware WPS button setup

(1) Press and hold the **WPS button** on the Wireless-N Range Extender for 2 seconds, the ‘**WPS**’ LED will start flashing.

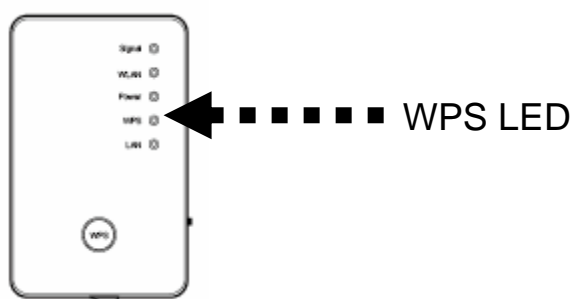
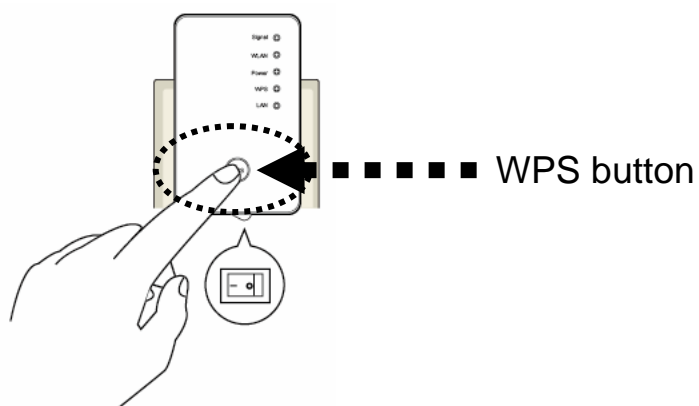

(2) Press the **WPS button** on the wireless broadband router or access point you wish to connect to within 2 minutes.

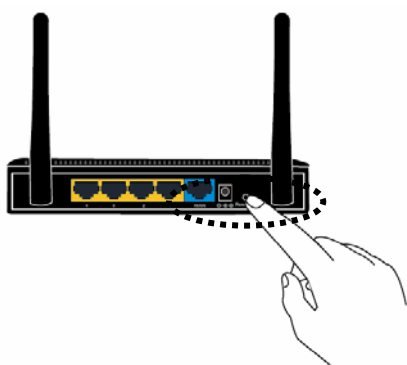

NOTE: the WPS button position on the access point above is for reference, different devices may have different WPS button positions or locations.

TIP: If the access point you wish to connect to does not have a hardware WPS button, you can also use its web configuration menu's WPS function to establish connection. Or you can login to the WAP-5883's web user interface to perform the quick setup (detailed setup refers to '2-1-2 Web browser quick setup' manual)

(3) If the WPS connection is successfully established, the '*WPS*' LED will stay lit for 5 minutes; if the '*WPS*' LED flashes fast, a problem has occurred, please wait for 2 minutes until the '*WPS*' LED goes off, and start from step(1) again.

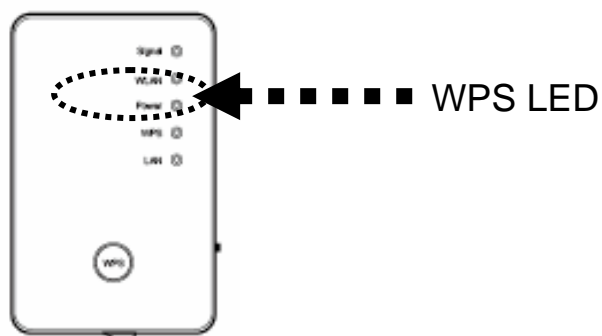

When quick installation is successful, the '*Signal*' LED will turn on.

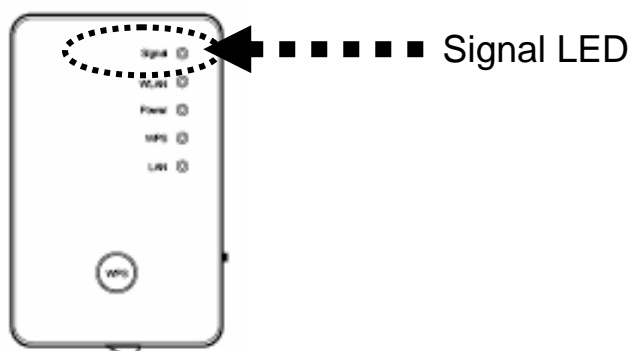

(4) Please move the Wireless-N Range Extender to the place you wish to use it (the ideal place will be the center of your house) and plug this Wireless-N Range Extender into a power outlet on the wall, the wireless connection will be established automatically as long as it's within range of your wireless router or access point.

You can check the '*Signal*' LED status to understand signal reception level.

Steady light: Excellent, Flashing: Good, Fast flash: poor.

NOTE: If the Signal LED is off, it means the device is out of wireless range of your wireless broadband router or access point. Please move this extender closer to the broadband router until the extender device can receive a signal from the broadband router and extend its signal.

The quick installation setup is complete, you can refer to ‘2-2 Repeater mode Advanced Settings’ to login to the web user interface for other advanced settings.

2-1-2 Web browser quick setup

Before you can connect to the Wireless-N Range Extender and start the configuration procedures, your computer must be able to get an IP address automatically (use dynamic IP address). If it’s set to use a static IP address, or you’re unsure, please refer to ‘Chapter V: Appendix, 5-1 Configuring TCP/IP on PC’ to set your computer to use dynamic IP address.

(1) Use an Ethernet cable to connect your computer’s Ethernet port and the Wireless-N Range Extender’s Ethernet port.

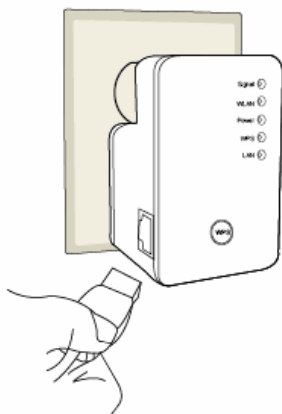

Or use your computer’s wireless configuration utility to search for an access point named ‘**comtrend**’ and get connected. (The default SSID of this Wireless-N Range Extender is ‘comtrend’)



(2) Open your web browser and input '**http://192.168.0.2**' in the address bar.

***NOTE:** By default the Comtrend WAP-5883 has a default IP address of 192.168.0.2. To login through the Web Management interface, your computer (whether connected wireless or via Ethernet directly to the Wireless-N Range Extender) will need to have an IP in the same range: 192.168.0.x. (where x equals any number between 3 and 254). If your network has a different IP range, set your computer to a static IP to configure this Wireless-N Range Extender for the first time and set it to match your network settings.*

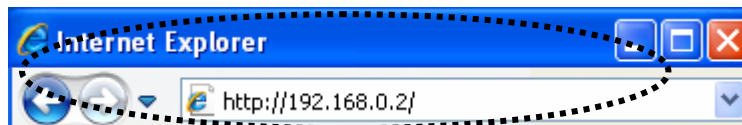

(3) The Wireless-N Range Extender will prompt you to input the username and password. Default username is '**admin**' and password is '**admin**'. Click the 'OK' button to continue.

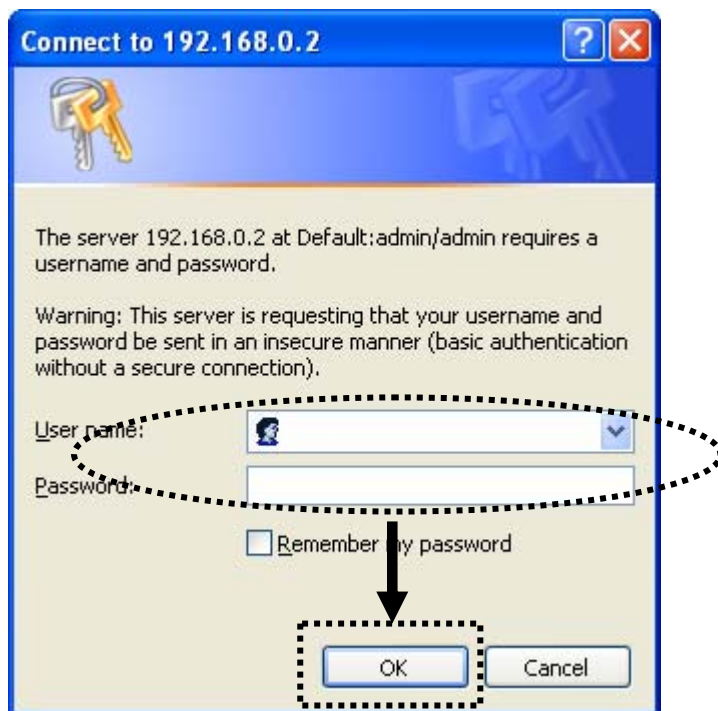

(4) All wireless access points nearby will be displayed in the list. Select one access point you want to connect to and click the 'Next' button to continue. If the access point you wish to connect to does not appear here, click the 'Refresh' button until it appears in the list, or try to move the Wireless-N Range Extender closer to the access point you wish to connect to.

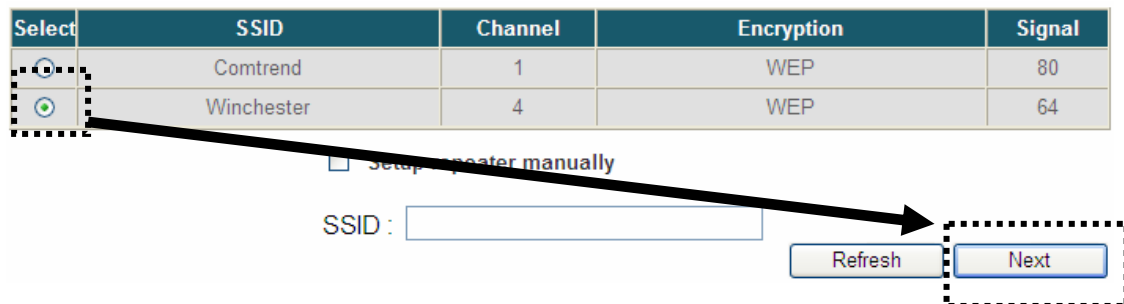

(5) If the Wireless Router or Access Point you're connecting to is using encryption, you'll be prompted to input the access point's wireless security key. Input it in the 'KEY' field and click the 'Next' button to continue.

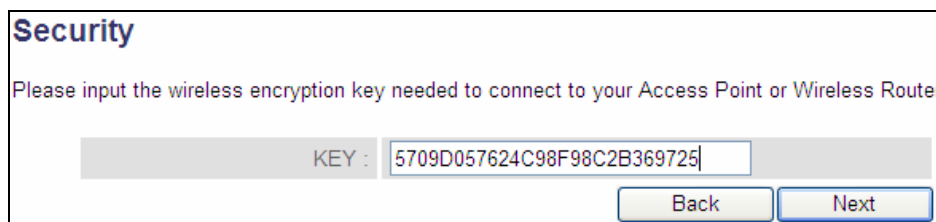

(6) Upon successful Connection Test completion the following message will be displayed. Click the 'Next' button to continue.



(7) The Wireless-N Range Extender will display the connection information for you. If everything is correct, click the 'APPLY' button to get connected.

The 'Device SSID' will be the same as the access point's SSID you connected in this step.

Save settings successfully!

Please press APPLY button to restart the system to make the changes take effect.

Connected Access Point SSID : **Winchester**

Device SSID :

Security : **WEP**

(8) Please wait for a few moments for the Wireless-N Range Extender to restart.

System Restarting!

5% 

(9) After the reboot is complete, the following will be displayed upon successful connection.

Congratulation! Your repeater is connected.

Device Name : **Winchester**

Security Key : **5709D057624C98F98C2B369725**

(10) Click the 'Refresh' button of your browser to login to the Wireless-N Range Extender's home page of the Web user interface to make additional setting changes.

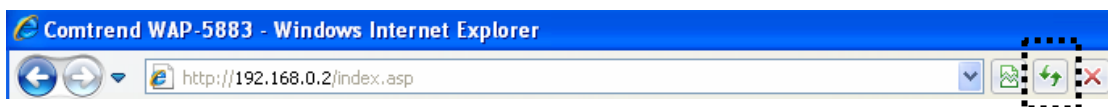

NOTE: After the wireless connection of this extender and the wireless broadband router is built, the extender is set to DHCP client mode and will get an IP address from the broadband router automatically. If you want to login to the web user interface of the repeater mode, please refer to '2-2 Repeater mode Advanced Settings' for more functions or learn how to login to the web UI again.

2-2 Repeater mode Advanced Settings

2-2-1 Setup IP address

The default IP address of this Wireless-N Range Extender is **192.168.0.2**, please make sure your PC's IP is within the range of 192.168.0.3~192.168.0.254.

Before you can login to the web user interface, you need to set your computer's IP address to any IP within this subnet. If you don't know how to do this, refer to following instructions.

Windows XP IP address setup:

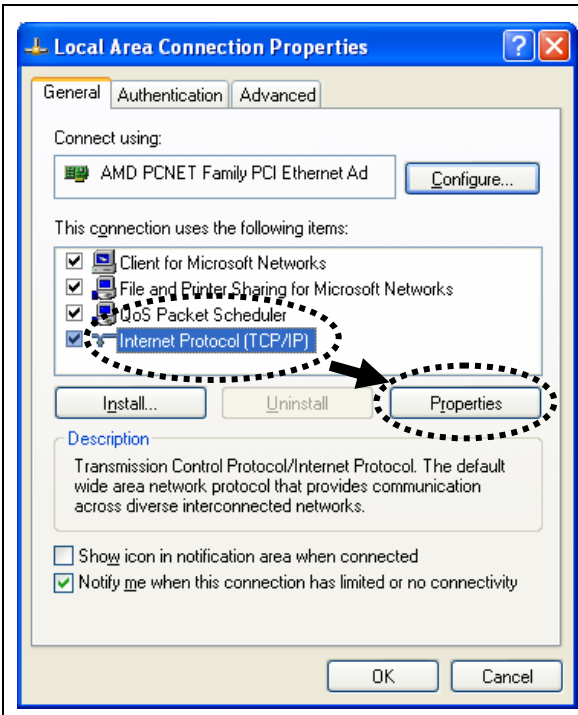
	<p>Click the 'Start' button (it should be located at the lower-left corner of your computer), then click control panel. Double-click the Network and Internet Connections icon, click Network Connections, and then double-click Local Area Connection, the Local Area Connection Status window will appear, and then click the 'Properties' button.</p>
---	--

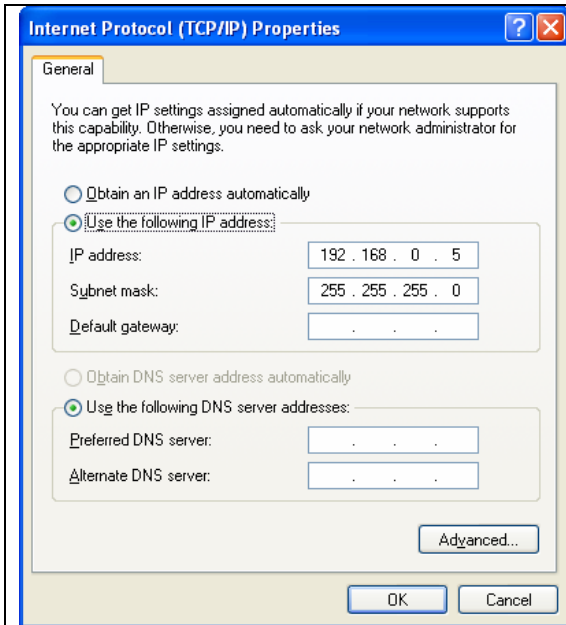

Select 'Use the following IP address', and then input the following settings in their respective fields:

IP address: 192.168.0.x (where x is an integer greater than 2 or less than 254, if there's more than one computer that needs to use this Wireless-N Range Extender on the same network, every computer should use a unique number)
 Subnet Mask: 255.255.255.0
 Click the 'OK' button when finished.

Windows Vista/7 IP address setup:

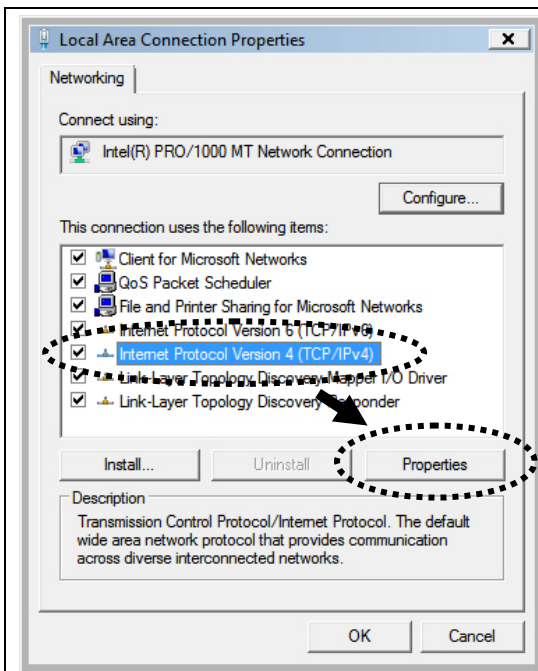

Click the 'Start' button (it should be located at the lower-left corner of your computer), then click control panel. Click **View Network Status and Tasks**, and then click **Manage Network Connections**. Right-click **Local Area Network**, then select **'Properties'**. The **Local Area Connection Properties** window will appear, select 'Internet Protocol Version 4 (TCP / IPv4)', and then click the 'Properties' button.

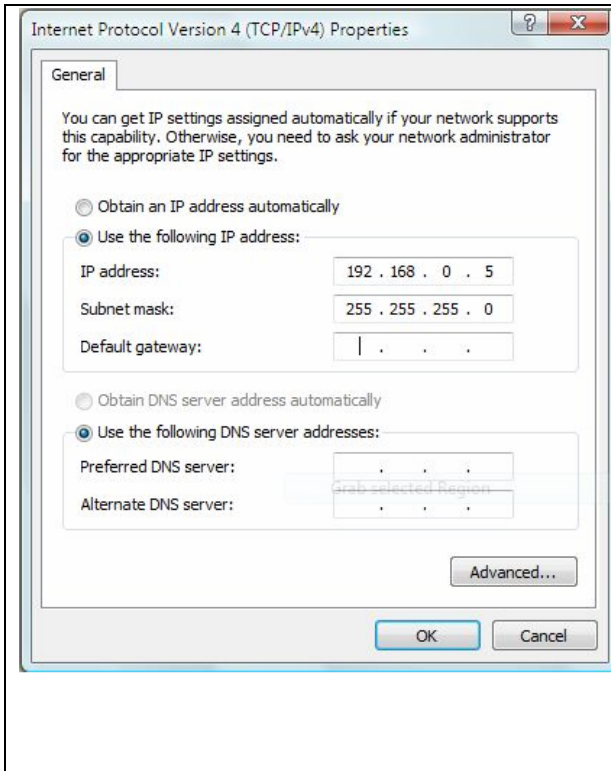

Select 'Use the following IP address', then input the following settings in their respective fields:

IP address: 192.168.0.x (where x is an integer greater than 2 or less than 254, if there's more than one computer that needs to use this Wireless-N Range Extender on the same network, every computer should use a unique number)

Subnet Mask: 255.255.255.0

Click the 'OK' button when finished.

2-2-2 Connect to web configuration menu

Please open your web browser (IE, Firefox, Chrome etc.) and input **192.168.0.2** in address bar then press the ENTER key:

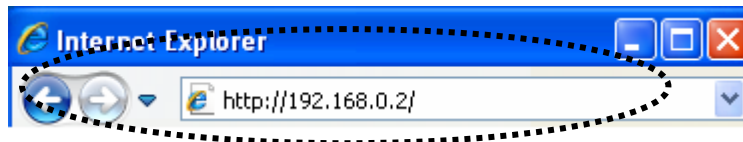

The Wireless-N Range Extender will prompt you to input the username and password. The default username is '**admin**' and password is '**admin**'. Click the 'OK' button to continue.

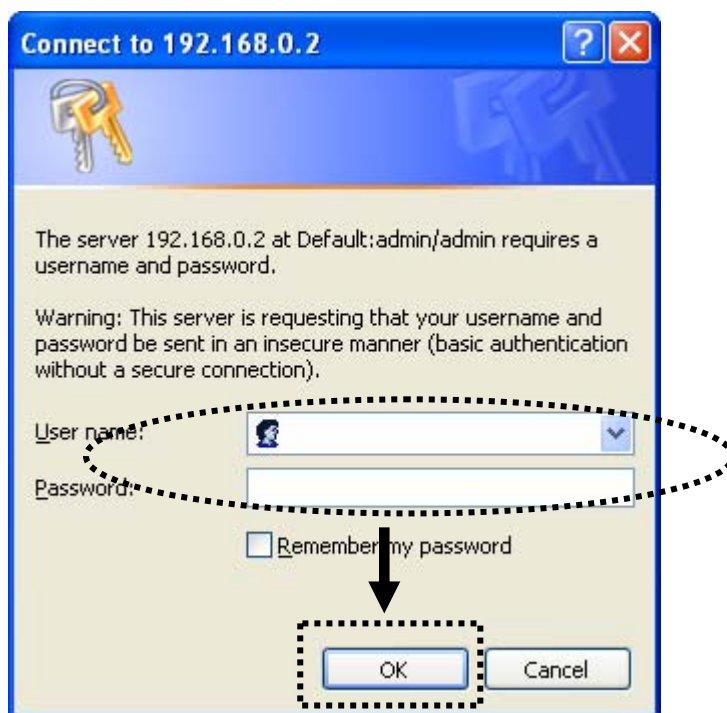

System	
Uptime	0day:0h:0m:46s
Hardware Version	Rev. A
Runtime Code Version	1.05
Wireless Configuration	
Mode	Universal Repeater
ESSID	Winchester
Channel Number	4
Security	WEP
BSSID(MAC)	80:1F:02:41:CC:3A
Associated Clients	0 <input type="button" value="Show Active Clients"/>
State	Connected
LAN Configuration	
IP Address	192.168.0.2
Subnet Mask	255.255.255.0
Default Gateway	
MAC Address	80:1F:02:41:CC:3A

Detailed operation instructions will be given below.

2-2-3 Home

The following information provides an overview of this Wireless-N Range Extender's status and network configuration.

To access the 'Home' menu, click 'Home' on the left.

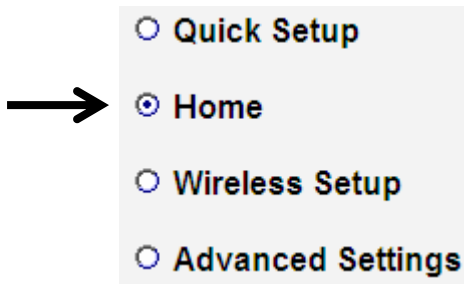

You should see a screen that looks like this (the contents will vary depending on your actual settings):

System	
Uptime	0day:0h:0m:46s
Hardware Version	Rev. A
Runtime Code Version	1.05
Wireless Configuration	
Mode	Universal Repeater
ESSID	Winchester
Channel Number	4
Security	WEP
BSSID(MAC)	80:1F:02:41:CC:3A
Associated Clients	0 <input type="button" value="Show Active Clients"/>
State	Connected
LAN Configuration	
IP Address	192.168.0.2
Subnet Mask	255.255.255.0
Default Gateway	
MAC Address	80:1F:02:41:CC:3A

You can click the 'Show Active Clients' button to show all connected wireless clients.

Please note: By clicking the 'Show Active Clients' button, a new browser window will appear. If your browser prevents the pop-up window from appearing, please disable this function or you will not be able to use the 'Show Client' function.

2-2-4 Wireless Setup – SSID

To access the ‘SSID’ page, click ‘Wireless Setup’ on the left, and then click ‘SSID’.

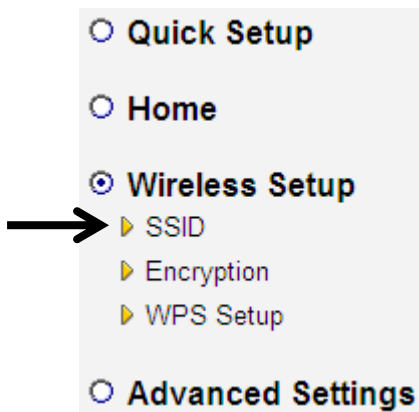

Basic Settings

SSID stands for Service Set Identifier. All stations must be configured with the correct SSID to access the Wireless Network.

Band :	2.4 GHz (B+G+N) ▾
MAIN ESSID :	Winchester
Channel Number :	1 ▾
Associated Clients :	Show Active Clients
Root AP SSID :	Winchester Select Site Survey

- Enable LED OFF mode
- Turn off all LED
 - Turn off all LED except POWER LED

Apply Cancel

The description of every setup item is listed here:

Item	Description
Band	Select the band you want to use; all the wireless clients must follow the same setting to connect to this repeater.

MAIN ESSID	This is the name of the wireless network for this Wireless-N Range Extender.
Channel Number	This is the radio frequency used to transmit and receive the wireless signal. The wireless devices in the same network should follow the same channel setting.
Associated Clients	Click the 'Show Active Clients' button, and then an "Active Wireless Client Table" will pop up. You can see the status of all active wireless stations that are connected to the access point.
Root AP SSID Select Site Survey	This Wireless-N Range Extender can act as a station to connect to a Root AP. It displays the SSID name of the Root AP it has connected to. Click the 'Select Site Survey' button to choose a new Root AP.
Enable LED off mode	You can enable or disable LED lights. Check ' Enable LED OFF ' mode to setup LED behavior: Turn off all LED: disables all LED lights Turn off all LED except the POWER LED: all LED lights will be disabled, except the 'POWER' LED

2-2-5 Wireless Setup – Encryption

To access the 'Encryption' page, click 'Wireless Setup' on the left, and then click 'Encryption'.



Security

This page allows you to specify whether a network key is used for authentication to the wireless network. If network authentication is set to Disabled, then no authentication is provided.

Encryption :

Select the security type of the wireless link:

Encryption: Disable (no security), WEP, WPA pre-shared key, or WPA RADIUS and click the 'APPLY' button.

NOTE: For WPS2.0 compliance specification, WEP and WPA-PSK encryption cannot support WPS connection; some wireless devices may follow this latest WPS2.0 specification, so we recommend using WPA2-PSK Encryption or (Network Authentication Open – WEP Encryption Disabled) to avoid interoperability problems.

WEP encryption: Select key length (64 or 128bit), key format (Hex or ASCII characters), Default Tx Key (by default 'Key 1'), and input key characters (refer to 'Key Format' you selected for number of characters)

WPA pre-shared key: Select one WPA Unicast Cipher Suite (it is recommended to use default setting 'WPA(TKIP)'), Pre-shared Key Format: Passphrase (alphanumeric characters) or Hex (64 Hex Characters), and input the key characters in the 'KEY' field.

WPA RADIUS: Only use this option if you have a RADIUS authentication server on your LAN. You have to input the RADIUS server's parameters (Server IP, port number, and password).

2-2-6 Wireless Setup - WPS Setup

This page allows you to change the WPS settings (Wi-Fi Protected Setup). WPS allows your wireless clients to connect automatically to the Access Point.

To access the 'WPS Settings' page, click 'Wireless Setup' on the left, and then click 'WPS Setup'.

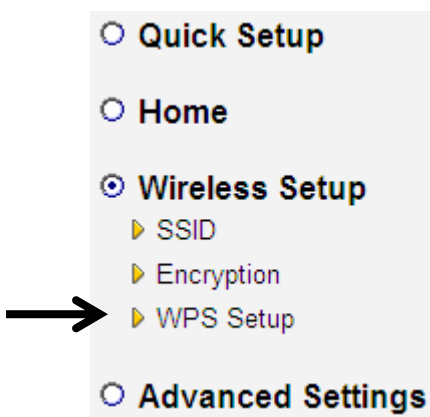

The following setup page will appear:

• Wi-Fi Protected Setup Information

WPS Status:	Configured
Self PinCode:	78665545
SSID:	Winchester
Authentication Mode:	WEP
Passphrase Key:	

• Device Configure

(Device is be a AP/router) Config Mode:	<input type="text" value="Registrar"/>
Configure via Push Button:	<input type="button" value="Start PBC"/>
Input client PIN code :	<input type="text"/> <input type="button" value="Start PIN"/>

The description of every setup item is listed here:

Item	Description
WPS Status	If the wireless security (encryption) function of this Wireless-N Range Extender is properly set, the WPS Status will display 'Configured'. If wireless security function has not been set, the WPS Status will display 'unConfigured'.
Self PinCode	This displays an 8-digit number for WPS PIN-style configuration. When another WPS-compatible device wishes to connect to this Wireless-N Range Extender and supports Self-PIN type WPS, input this number to the wireless device to establish connection.
SSID	SSID stands for Service Set Identifier. All stations must be configured with the correct SSID to access the Wireless Network.
Authentication Mode	Shows the authentication mode of this Wireless-N Range Extender.
Passphrase Key	This shows asterisks (*) to indicate that the wireless security is properly set.
Config Mode	There are 'Registrar' and 'Enrollee' modes for the WPS connection. When 'Registrar' is enabled, the wireless clients will follow the Wireless-N Range Extender's wireless settings for the WPS connection. When 'Enrollee' mode is enabled, the Wireless-N Range Extender will follow the wireless settings of wireless router for the WPS connection.
Start PBC	Click the 'Start PBC' button to start the Push-Button style WPS setup procedure. This Wireless-N Range Extender will wait for WPS requests from another wireless device for 2 minutes. The 'WPS' LED on the Wireless-N Range Extender will be blinking for 2 minutes when this Wireless-N Range Extender is waiting for an incoming WPS request.

Start PIN	Input the PIN code of the wireless client you wish to connect to, and click the 'Start PIN' button. The 'WPS' LED on the Wireless-N Range Extender will be blinking when this Wireless-N Range Extender is waiting for an incoming WPS request.
-----------	---

2-2-7 Advanced Settings

To access the 'Advanced Settings' menu, click 'Advanced Settings' on the left.

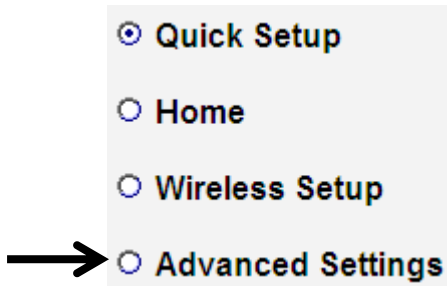

The following setup page will appear:

Fragment Threshold:	<input type="text" value="2346"/>	(256-2346)
RTS Threshold:	<input type="text" value="2347"/>	(0-2347)
Beacon Interval:	<input type="text" value="100"/>	(20- (20-1000 ms)
DTIM Period:	<input type="text" value="3"/>	(1-10)
Data Rate:	<input type="button" value="Auto"/>	
N Data Rate:	<input type="button" value="Auto"/>	
Channel Width:	<input checked="" type="radio"/> Auto 20/40 MHz	<input type="radio"/> 20 MHz
Preamble Type:	<input checked="" type="radio"/> Short Preamble	<input type="radio"/> Long Preamble
Broadcast ESSID:	<input checked="" type="radio"/> Enable	<input type="radio"/> Disable
WMM:	<input type="radio"/> Enable	<input checked="" type="radio"/> Disable
CTS Protect:	<input checked="" type="radio"/> Auto	<input type="radio"/> Always <input type="radio"/> None
TX Power:	<input type="button" value="100 %"/>	

- Enable LED OFF mode**
- Turn off all LED
 - Turn off all LED except POWER LED

The description of every setup item is listed here:

Item	Description
Fragment Threshold	The threshold (number of bytes) of the fragmentation boundary for directed messages. It is the maximum data fragment size that can be sent. Input a value between 256 and 2346.
RTS Threshold	The RTS (Request To Send) threshold parameter controls what size data packet (number of bytes) the low level RF protocol issues to an RTS packet. The default is 2347.
Beacon Interval	The Beacon Interval value indicates the frequency interval of the beacon. Enter a value between 20 and 1000. A beacon is a packet broadcast by the Router to synchronize the wireless network. The default value is 100.
DTIM Period	Configures DTIM (Delivery Traffic Indication Message) send period. The default value is 3.
Data Rate	Select wireless data transfer speed. When you select a value here, this Wireless-N Range Extender will refuse to establish connection with wireless clients by other speeds. It's recommended to select 'Auto' and this Wireless-N Range Extender will adjust the speed automatically.
N Data Rate	Select wireless data transfer speed (MCS0 to MCS15). MCS stands for Modulation and Coding Scheme, which represents different speeds when the bandwidth is 20MHz or 40MHz. It's recommended to select 'Auto' and this Wireless-N Range Extender will adjust the speed automatically.
Channel Width	Select the wireless channel width, 20MHz or 40MHz. 40MHz provides better network speed for 802.11n wireless clients. However, if there are 802.11b / g clients connecting to this Wireless-N Range Extender, it will switch to 20MHz mode automatically.

Preamble Type	<p>The Preamble type defines the length of the CRC (Cyclic Redundancy Check) block for communication between the Access Point and roaming wireless adapters.</p> <p>Do not modify the default value if you don't know what it is, default setting is 'Short Preamble'.</p>
Broadcast ESSID	<p>When set to 'enabled', every wireless device can scan and find this Wireless-N Range Extender; when set to 'disabled', only wireless clients who know the exact SSID can get connected with this Wireless-N Range Extender. Setting to disabled will help to improve security.</p>
WMM	<p>Enable or disable Wireless Multi-Media. When enabled, the Wireless-N Range Extender will give priority to multimedia related network applications for better performance.</p>
CTS Protect	<p>This function provides CTS (Clear to Send) protection when transferring data. Selecting 'Auto' for this option is recommended.</p>
TX Power	<p>Select the wireless transmitting power level, from 10% to 100%. When wireless clients are not too far from this Wireless-N Range Extender, you don't have to select a higher power level, since this may cause some individuals to attempt to break into your wireless network if you have a bad password, or no password.</p>
Enable LED off mode	<p>You can enable or disable LED lights.</p> <p>Check 'Enable LED OFF' mode to setup LED behavior:</p> <p>Turn off all LED: disables all LED lights</p> <p>Turn off all LED except the POWER LED: all LED lights will be disabled, except the 'POWER' LED</p>

When you finish the settings in this page, click the 'Apply' button. You'll see the following message:

Save settings successfully!

You may press CONTINUE button to continue configuring other settings or press APPLY button to restart the system to make the changes take effect.



If you want to configure this Wireless-N Range Extender more, click the 'CONTINUE' button; if you want to save the changes and use it now, click the 'APPLY' button.

System Restarting!

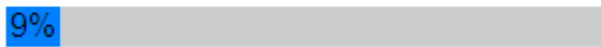

You'll be prompted to wait for 30 seconds before you can reconnect to this Wireless-N Range Extender.

2-2-8 MAC Address Filtering

For security reasons, the Comtrend WAP-5883 supports MAC Address Filtering, which only allows authorized MAC Addresses to associate with the Wireless-N Range Extender. Up to 20 entries can be configured.

This will enhance security because you can make a ‘white list’ allowing users in the list to use this Wireless-N Range Extender. Clients who aren’t on this white list can’t get connected, even if they know the password.

To access the ‘MAC Filtering’ menu, click ‘MAC Filtering’ on the left.

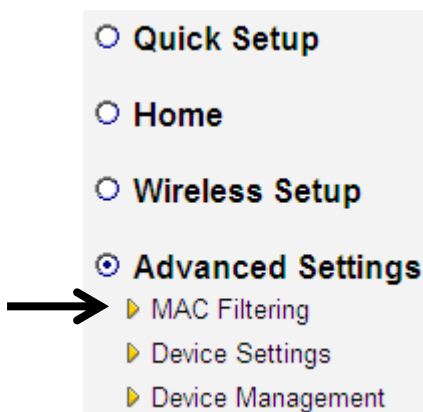

The following setup page will appear:

• MAC Address Filtering Table

NO.	MAC Address	Comment	Select
-----	-------------	---------	--------

Delete Selected Delete All Reset

Enable Wireless Access Control

New	MAC Address: <input type="text"/>	Comment: <input type="text"/>	Add	Clear
-----	--------------------------------------	----------------------------------	-----	-------

APPLY CANCEL

The description of every setup item is listed as follows:

Item	Description
Enable Wireless Access Control	Check this box to enable MAC filtering. If you don't check this box, anyone who knows the wireless password can get connected to this Wireless-N Range Extender.
MAC Address	Input the MAC address of the clients you wish to deny or provide access to the Wireless-N Range Extender into the MAC address list. Input 12 HEX characters here, you don't have to add : (colon) or - (dash) characters every 2 characters. <i>If you don't know how to get the MAC address of a network client, see the following page.</i>
Comment	Input any descriptive text about this rule, so you can remember the purpose of this rule. Input up to 20 alphanumerical characters in this field.
Add	Add this MAC address to the list.
Clear	Clear the 'MAC Address' and 'Comment' field.
Delete Selected	Delete the MAC address(es) whose 'Select' box you checked.
Delete All	Delete all MAC addresses in the list. You'll be prompted to confirm the deletion first.
Reset	Uncheck all checked boxes.
Select	All existing MAC addresses will be listed here. To delete a MAC address from the list, check the box of the MAC address you wish to delete first. You can select more than one MAC address here.

When you complete the settings in this page, click the 'Apply' button. You'll see the following message:

Save settings successfully!

You may press CONTINUE button to continue configuring other settings or press APPLY button to restart the system to make the changes take effect.

If you still need to configure this Wireless-N Range Extender, click the 'CONTINUE' button; if you want to save changes and use it now, click the 'APPLY' button. You'll be prompted to wait for 30 seconds before you can reconnect to this Wireless-N Range Extender.

If you don't know the MAC address of your computer or wireless device, you can follow the procedure below:

For wireless devices and computers that are connected to this Wireless-N Range Extender already, you can click the 'Show Active Clients' button on the 'Home' setting page.

Wireless Configuration	
Mode	Universal Repeater
ESSID	Winchester
Channel Number	4
Security	WEP
BSSID(MAC)	80:1F:02:41:CC:3A
Associated Clients	0 <input type="button" value="Show Active Clients"/>
State	Connected

Their MAC address will be displayed in the 'MAC Address' field.

If you still can't identify the MAC address of your computer, you can follow this procedure:

Click the network icon located at the lower-right corner, then click 'Open Network and Sharing Center'.

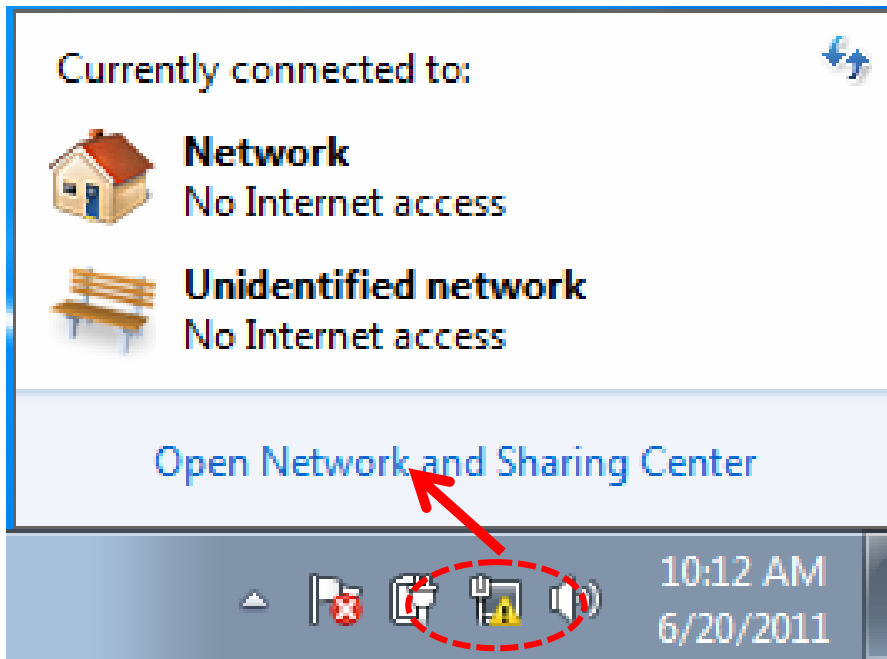

Click the connection that will be used to connect the Wireless-N Range Extender (in this example, 'Local Area Connection'):

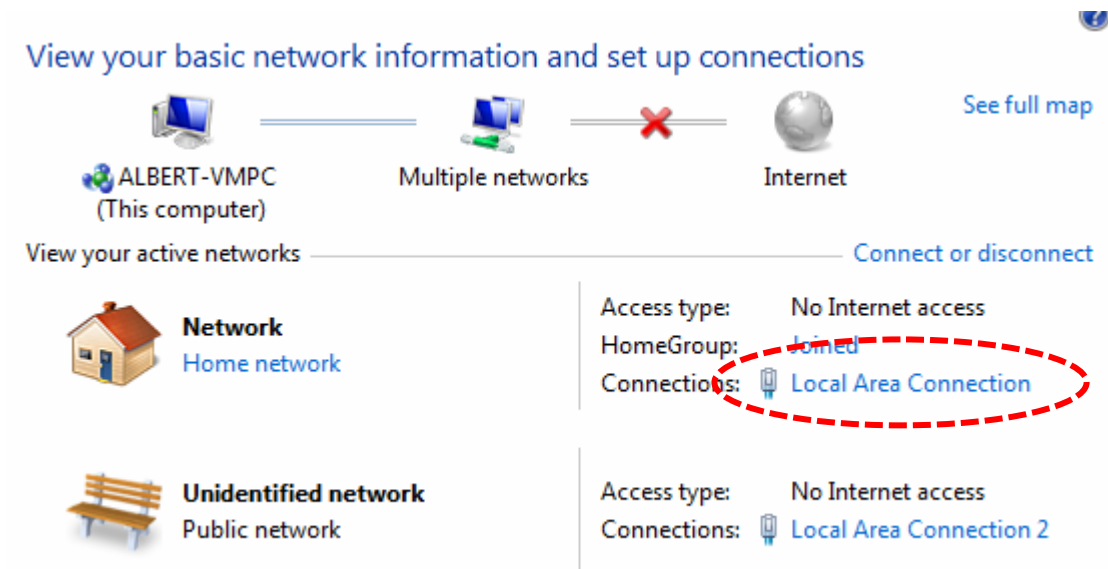

Click the 'Details...' button.

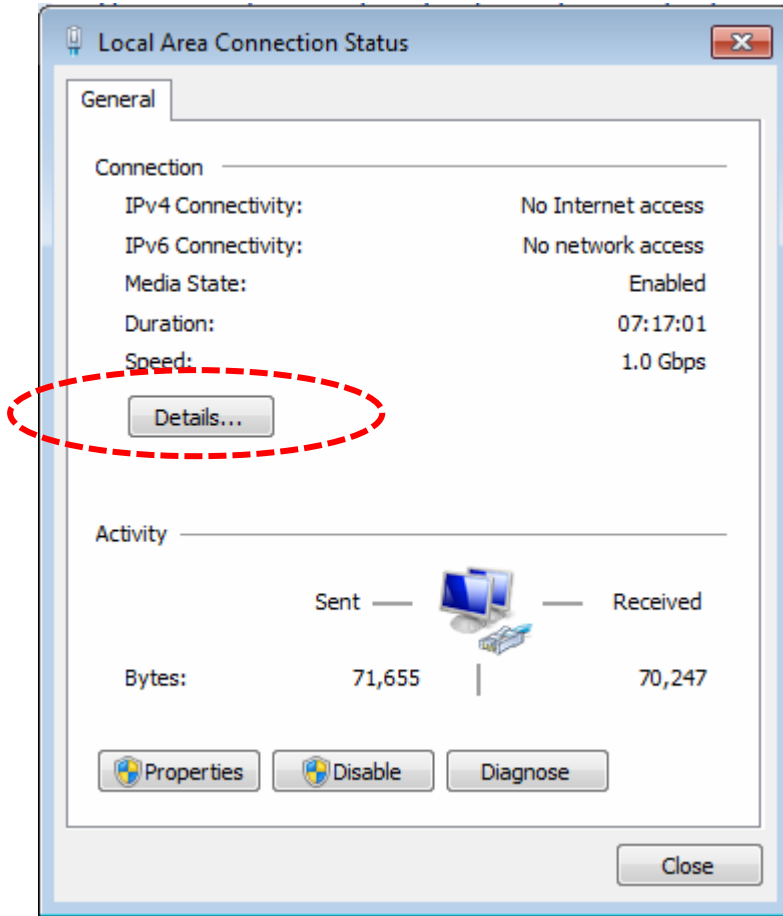

The MAC address of selected network connection will be displayed here as 'Physical Address'.

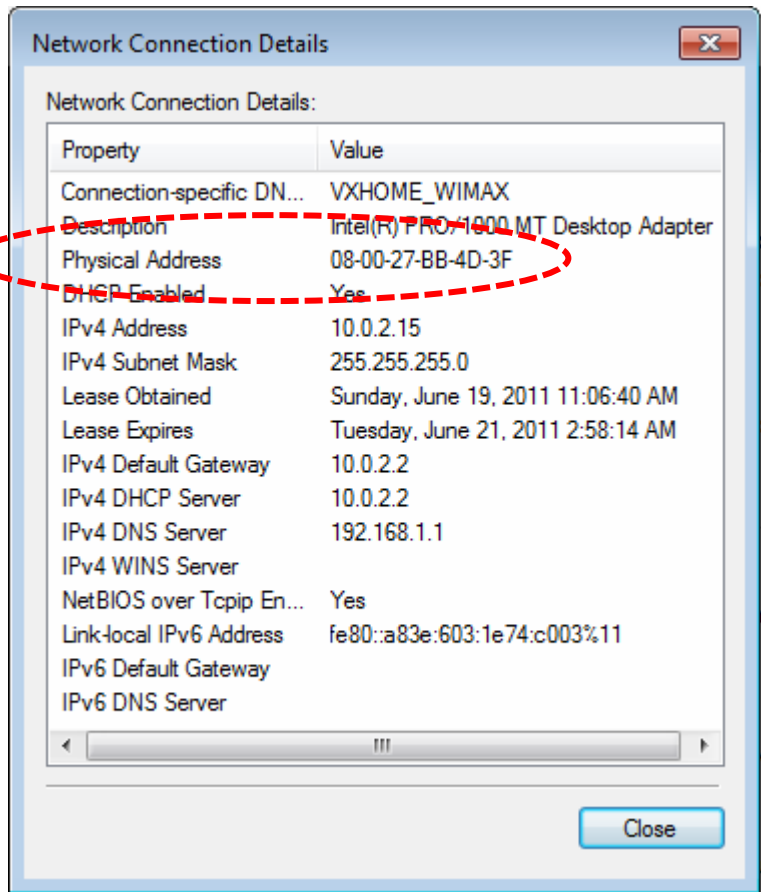

2-2-9 System Utility

You can change the settings of several system-level parameters in this page, including the administrator's password, and IP address.

To access the 'System Utility' menu, click 'Device Settings' on the left.

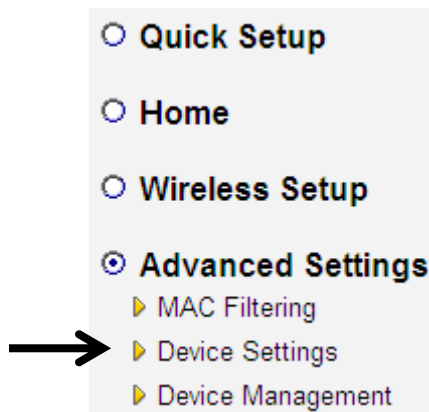

The following setup page will appear:

- **Password Settings**

Current Password :	<input type="text"/>
New Password :	<input type="text"/>
Re-Enter Password :	<input type="text"/>

- **Management IP**

IP Address :	<input type="text" value="192.168.0.2"/>
Subnet Mask :	<input type="text" value="255.255.255.0"/>
Gateway Address :	<input type="text"/>

The description of every setup item is listed here:

Password Settings

The default password of this Wireless-N Range Extender is admin, and it's displayed on the login prompt when accessed from the web browser. There's a security risk if you don't change the default password, since everyone can see it. This is very important when you have the wireless function enabled.

Here are descriptions of every setup item:

Item	Description
Current Password	To change the password, you have to input the current password first.
New Password	Input the new password here. You can use a combination of letters, numbers, and symbols for up to 20 characters.
Re-Enter Password	Input the new password again for conformation.

Management IP

To set up the IP address of this Wireless-N Range Extender, please see the following.

Item	Description
IP Address	<p>Input the IP address for the Wireless-N Range Extender's LAN / Wi-Fi port.</p> <p><i>NOTE: Please remember this IP address. If you forget this IP address and you didn't use the DHCP server function to assign the IP address to clients, you won't be able to connect to this Wireless-N Range Extender and you'll need to clear all settings and password to reset the IP address back to the default value '192.168.0.2'. (Press the WPS button and hold for 10 seconds to restore all settings to factory defaults)</i></p>
Subnet Mask	Input the subnet mask of the IP address you're using.
Gateway Address	Input the gateway's IP address of your network. Generally you can use '0.0.0.0' (default value) since this Wireless-N Range Extender will access the Internet via the WAN port.

When you complete the settings in this page, click the 'Apply' button. You'll see the following message:

Save settings successfully!

You may press CONTINUE button to continue configuring other settings or press APPLY button to restart the system to make the changes take effect.

If you still need to configure this Wireless-N Range Extender, click the 'CONTINUE' button; if you want to save the changes and use it now, click the 'APPLY' button. You'll be prompted to wait for 30 seconds before you can reconnect to this Wireless-N Range Extender.

2-2-10 Configuration

You can backup and restore the configuration of this Wireless-N Range Extender without the need to reconfigure again.

This function is especially useful when you need to use this Wireless-N Range Extender in different places, like your home and a hotel.

To access the 'Configuration' menu, click 'Device Management' on the left.

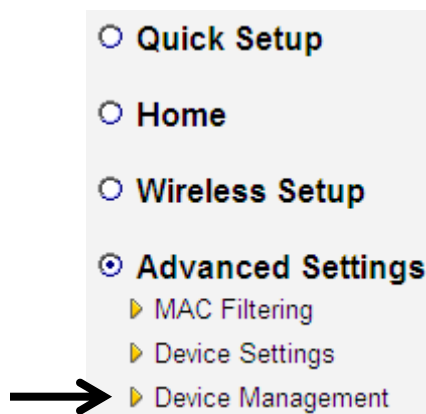

Configuration Tool

The following setup page will appear:

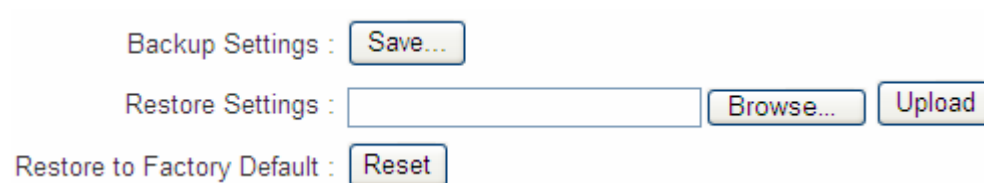

The description of every setup item is listed here:

Item	Description
Backup Settings	This option saves the Wireless-N Range Extender's current configuration settings to a local file on your computer. It will be named "config.bin." You can then use the "Restore Settings" option to restore the saved configuration to the Wireless-N Range Extender if it is reset or loses its configuration.

Restore Settings	<p>If you want to upload a saved configuration file to the Wireless-N Range Extender, please click the 'Browse' button to select a saved configuration file on your computer.</p> <p>Then click the 'Upload' button to replace the current settings.</p>
Reset to Factory Default	<p>To reset all the settings of this Wireless-N Range Extender to factory defaults, including the password. You'll be prompted to confirm the settings reset:</p> <div data-bbox="496 663 1350 1003" style="border: 1px solid gray; padding: 10px; margin: 10px 0;"> <p>Message from webpage</p> <p> Do you really want to reset the current settings to default?</p> <p style="text-align: right;"> <input type="button" value="OK"/> <input type="button" value="Cancel"/> </p> </div> <p>Click 'OK' if you really want to restore all settings, or click 'Cancel' to abort.</p>

WEB Upgrade

The software running in this Wireless-N Range Extender (i.e. 'Firmware') can be upgraded to improve the functionality of this Wireless-N Range Extender.

It is recommended that you upgrade the firmware from a wired computer. Enter the path and name of the upgrade file and then click the APPLY button.

You can access our website to look for the latest firmware file. Then download the latest firmware file and save on your computer and upload to your Wireless-N Range Extender.

WEB Upgrade

It is recommended that you upgrade the firmware from a wired computer. Enter the path and name of the upgrade file and then click the APPLY button below.

The description of every setup item is listed here:

Item	Description
Browse	Select a firmware file saved on your computer.

After selecting the firmware file, click the ‘Apply’ button to start the firmware upgrade procedure.

Reset

In the event that the system stops responding correctly or stops functioning, you can perform a standard Reset or Reset to Defaults. A standard Reset will retain your settings and reboot the Wireless-N Range Extender, while resetting the device to defaults will erase all configuration settings.

Reset

In the event that the system stops responding correctly or stops functioning, you can perform a standard Reset or Reset to Defaults. A standard Reset will retain your settings and reboot the device, while resetting the device to defaults will erase all configuration settings.

APPLY

To reset this Wireless-N Range Extender, click the ‘Apply’ button. You’ll be prompted to confirm the reset:

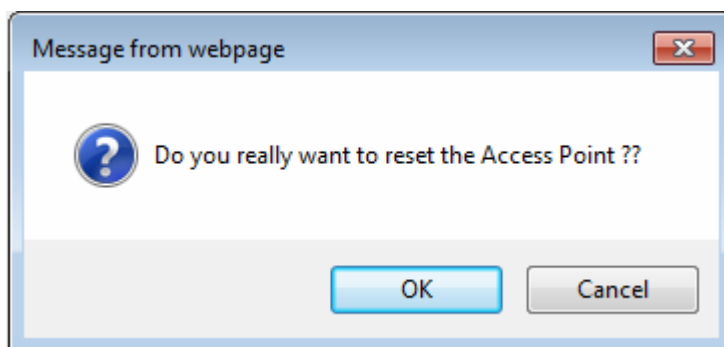

Click the ‘OK’ button to reset the Wireless-N Range Extender, or click ‘Cancel’ to abort.

CHAPTER III: Client Mode

Client mode allows your networking device to have wireless capability; it will become your networking device's wireless network adapter. You can connect this device to the Ethernet port of your existing Internet TV or DVD player or game console device with an Ethernet cable.

This chapter will explain how to quickly install this Wireless-N Range Extender by using the quick setup method and explain the detailed settings on the web user interface page of client mode.

3-1 Client Mode Quick Installation Guide

Switch mode selector to '**Client**'.

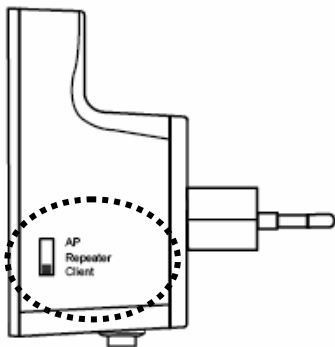

Plug this Wireless-N Range Extender into a power outlet on the wall, and flip the power switch to '**ON**' (1). You should see the '**Power**' LED light up in few seconds (2). If not, check if the power outlet you're using is working.

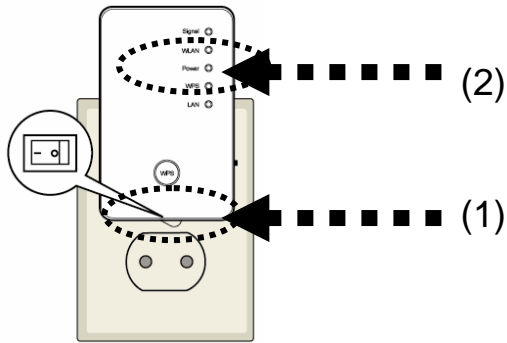

Connect your wired networking device (wired PC, or Internet TV, or game console..etc.) and this Wireless-N Range Extender by Ethernet cable.

NOTE: You must set your networking device as DHCP client (obtain an IP address automatically from the DHCP server)

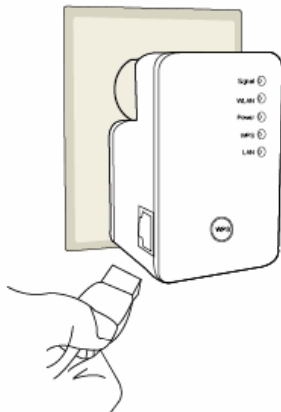

You can setup a wireless connection via the ‘Hardware WPS button’ or ‘Software web browser’.

If your broadband router or access point also supports a ‘WPS button’, we recommend you to use the WPS button to establish connection.

Using WPS button

- please go to section 3-1-1

Using Web browser

- please go to section 3-1-2

3-1-1 Hardware WPS button setup

(1) Press and hold the **WPS button** on the Wireless-N Range Extender for 2 seconds, the ‘**WPS**’ LED will start flashing.

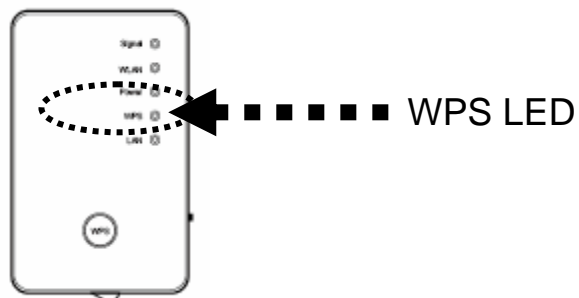
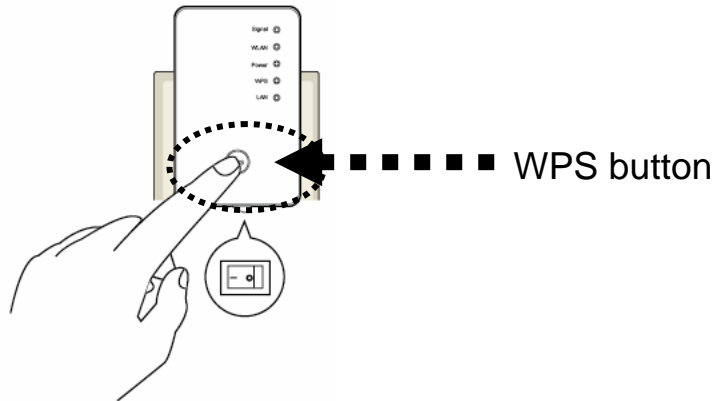

(2) Press the **WPS button** on the wireless broadband router or access point you wish to connect to within 2 minutes.

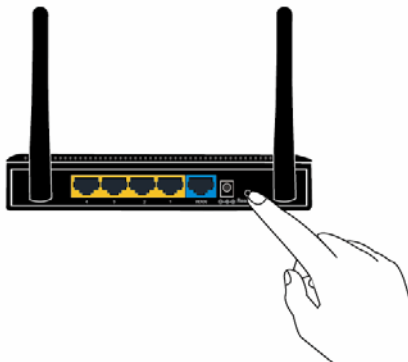

NOTE: the WPS button position on this access point is for reference, different devices may have different WPS button positions or locations.

TIP: If the access point you wish to connect does not have a hardware WPS button, you can also use its web configuration menu's WPS function to establish connection. Or you can login to this repeater's web user interface to perform the quick setup (detailed setup refers to '3-1-2 Web browser quick setup')

(3) If the WPS connection is successfully established, the '**WPS**' LED will stay lit for 5 minutes; if the '**WPS**' LED flashes fast, a problem has occurred, please wait for 2 minutes until the '**WPS**' LED is off, and start from step(1) again.

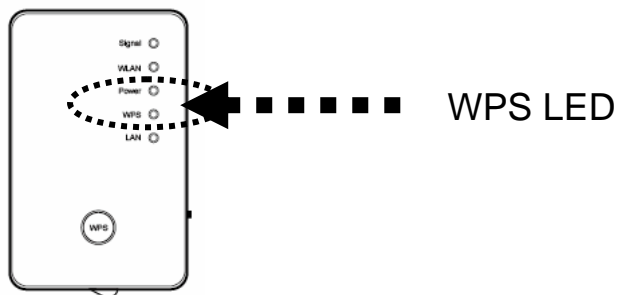

When quick installation is successful, the '**Signal**' LED will turn on.

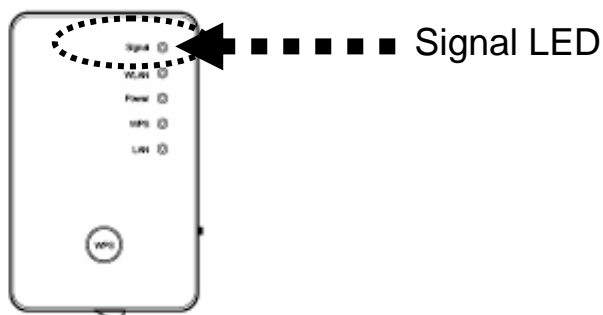

(4) When this Wireless-N Range Extender and your networking device (Internet TV or game console etc.) are connected via Ethernet cable, the wireless connection will be established automatically. You can check the '**Signal**' LED status to understand the signal reception level.

Steady light: Excellent, Flashing: Good, Fast flash: poor.

NOTE: If the Signal LED is off, it means the device is out of wireless range of your wireless broadband router or access point. Please move this extender closer to your broadband router until the extender device can receive a signal from the broadband router.

The quick installation setup is complete, you can refer to '3-2 Client Mode Advanced Settings' to login to the web user interface for other advanced settings.

3-1-2 Web browser quick setup

Before you can connect to the Wireless-N Range Extender and start configuration procedures, your computer must be able to get an IP address automatically (use dynamic IP address). If it's set to use static IP address, or you're unsure, please refer to '[Chapter V: Appendix, 5-1 Configuring TCP/IP on PC](#)' to set your computer to use dynamic IP address.

(1) Use an Ethernet cable to connect your computer's Ethernet port and the Wireless-N Range Extender's Ethernet port.

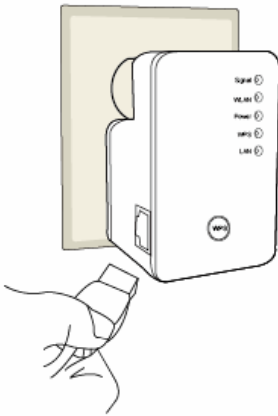

(2) Open your web browser and input '**http:// 192.168.0.2**' in the address bar.

NOTE: By default the Comtrend WAP-5883 has a default IP address of 192.168.0.2. To login through the Web Management interface, your computer (whether connected wirelessly or via Ethernet directly to the Wireless-N Range Extender) will need to have an IP in the same range: 192.168.0.x. (where x equals any number between 3 and 254). If your network has a different IP range, set your computer to a static IP to configure this Wireless-N Range Extender for the first time and set it to match your network settings.

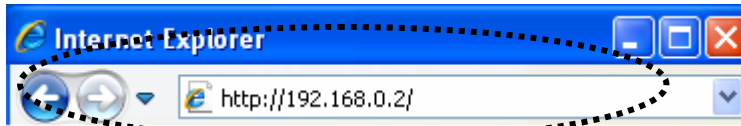

(3) The Wireless-N Range Extender will prompt you to input the username and password. The default username is 'admin' and password is 'admin'. Click the 'OK' button to continue.

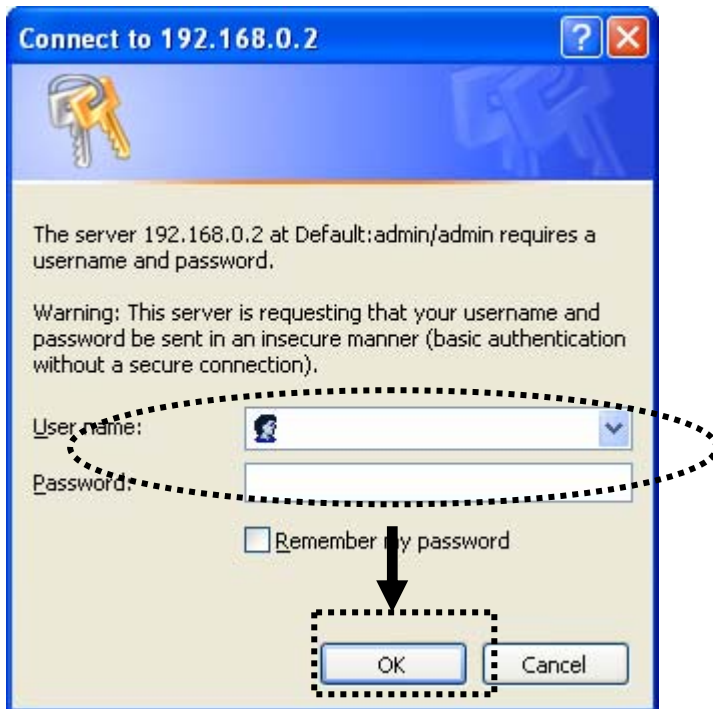

(4) All wireless access points nearby will be displayed in the list. Select the required access point and click the 'Next' button to continue. If the access point you wish to connect to does not appear here, click the 'Refresh' button until it appears in the list, or try to move this Wireless-N Range Extender closer to the access point you wish to connect to.

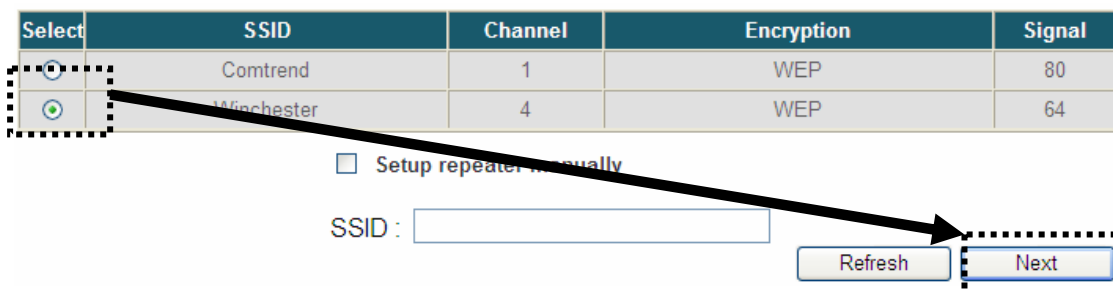

(5) If the Wireless Router or Access Point you're connecting to is using encryption, you'll be prompted to input the access point's wireless security key, input it in the 'KEY' field and click the 'Next' button to continue.

Security

Please input the wireless encryption key needed to connect to your Access Point or Wireless Router

KEY :

(6) Upon successful Connection Test completion the following message will be displayed. Click 'Next' to continue.

Connection Successful

Congratulations! Your device is now connected.

(7) The Wireless-N Range Extender will display the connection information for you. If everything's correct, please click the 'APPLY' button to get connected.

'Connected Access Point SSID' is the SSID of your access point that you selected to connect in the previous step, please double confirm all the information is correct, if you want to change it, you can press the 'Back' button to select again or press 'APPLY' to make the changes effective.

Save settings successfully!

Please press APPLY button to restart the system to make the changes take effect.

Connected Access Point SSID : **Winchester**

Security : **WEP**

(7) Please wait for a few moments for the Wireless-N Range Extender to restart.

System Restarting!

22%

(8) Click the 'Refresh' button of your browser to login to the client mode's home page of the Web user interface. You can close the browser and use your computer to connect to the wireless access point by the SSID you set in last step and start using the network.

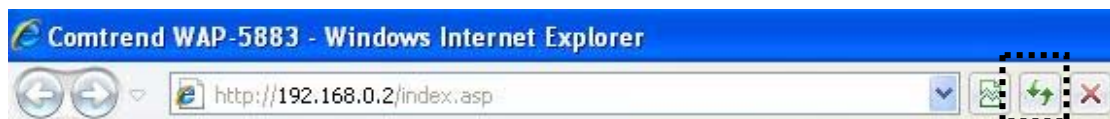

NOTE: After the wireless connection of this extender and the wireless broadband router is built, this device becomes DHCP client and will get an IP address from your broadband router automatically. If you want to login to the Web user interface of this repeater again, please refer to '3-2 Client Mode Advanced Settings'.

3-2 Client Mode Advanced Settings

3-2-1 Setup IP address

The default IP address of Client mode is **192.168.0.2**, please make sure your PC's IP is within the range of 192.168.0.3~192.168.0.254.

Before you can login to the web user interface, you need to set your computer's IP address to any IP within this subnet. If you don't know how to do this, please refer to following instructions.

Windows XP IP address setup:

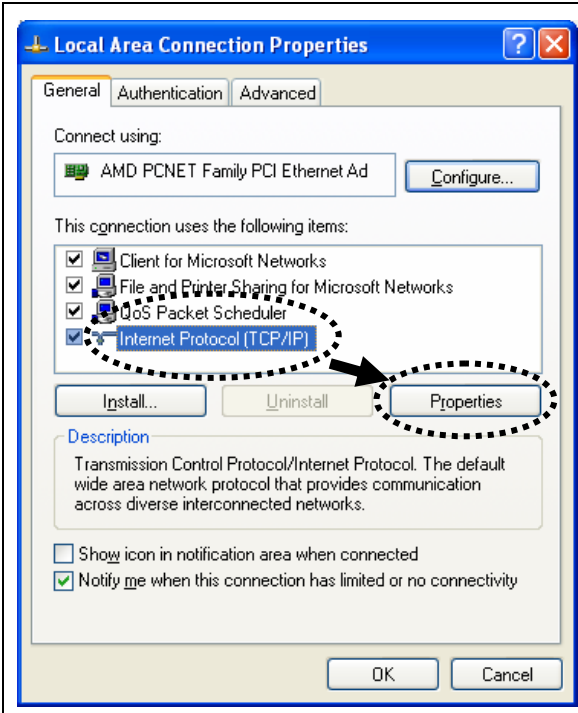
	<p>Click the 'Start' button (it should be located at the lower-left corner of your computer screen), then click control panel. Double-click the <i>Network and Internet Connections</i> icon, click <i>Network Connections</i>, and then double-click <i>Local Area Connection</i>, the <i>Local Area Connection Status</i> window will appear, click the 'Properties' button.</p>
--	--

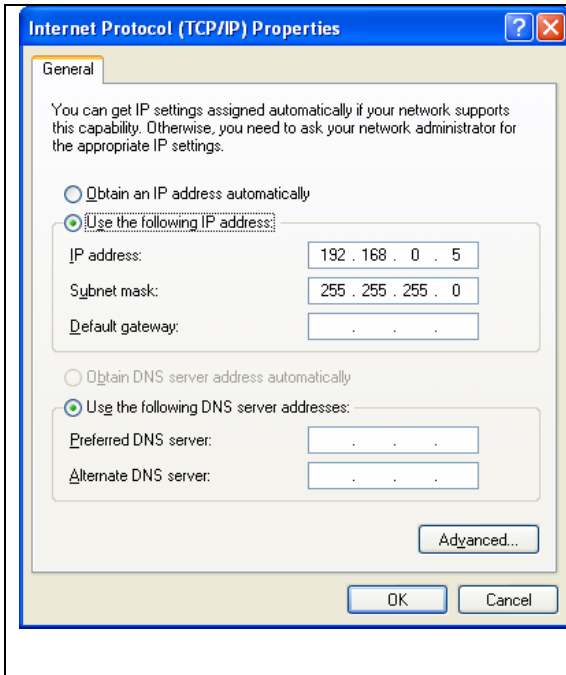

Select 'Use the following IP address', then input the following settings in their respective fields:

IP address: 192.168.0.x (where x is an integer greater than 2 or less than 254, if there's more than one computer that needs to use this Wireless-N Range Extender on the same network, every computer should use a unique number)
 Subnet Mask: 255.255.255.0
 Click the 'OK' button when finished.

Windows Vista/7 IP address setup:

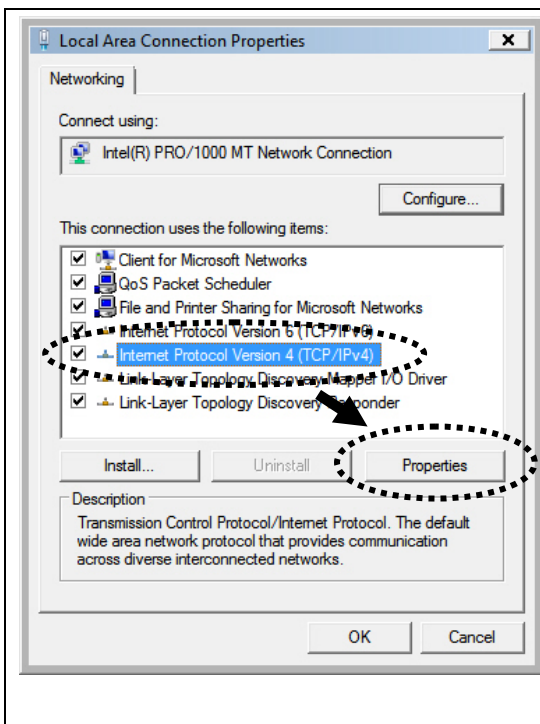

Click the 'Start' button (it should be located at the lower-left corner of your computer screen), then click control panel. Click **View Network Status and Tasks**, then click **Manage Network Connections**. Right-click **Local Area Network**, then select **'Properties'**. The **Local Area Connection Properties** window will appear, select 'Internet Protocol Version 4 (TCP / IPv4)', and then click the 'Properties' button.

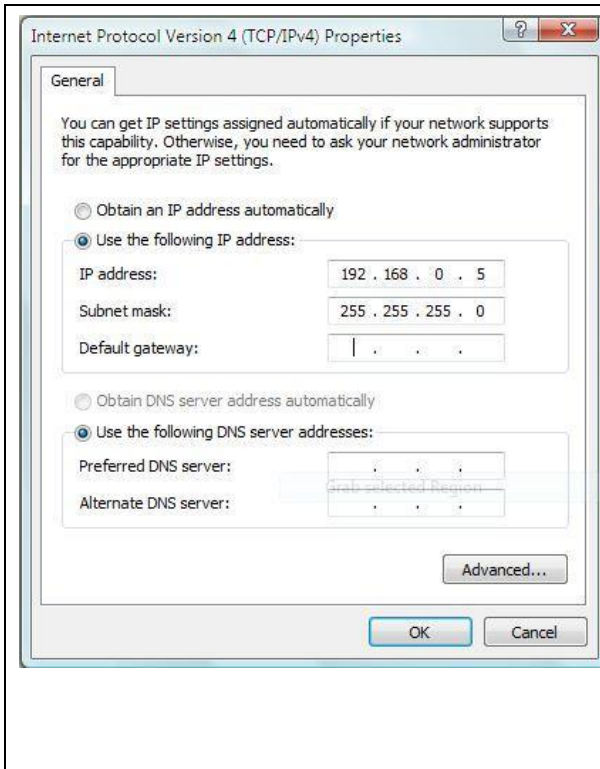

Select 'Use the following IP address', then input the following settings in their respective fields:

IP address: 192.168.0.x (where x is an integer greater than 2 or less than 254, if there's more than one computer that needs to use this Wireless-N Range Extender on the same network, every computer should use a unique number)

Subnet Mask: 255.255.255.0

Click the 'OK' button when finished.

3-2-2 Connect to web configuration menu

Please open your web browser (IE, Firefox, Chrome etc.) and input **192.168.0.2** in address bar then press the ENTER key:

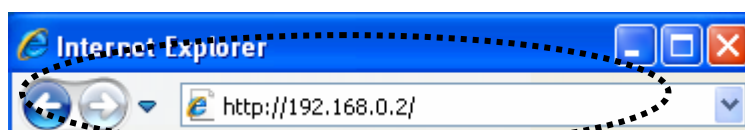

The Wireless-N Range Extender will prompt you to input the username and password. The default username is '**admin**' and password is '**admin**'. Click the 'OK' button to continue.

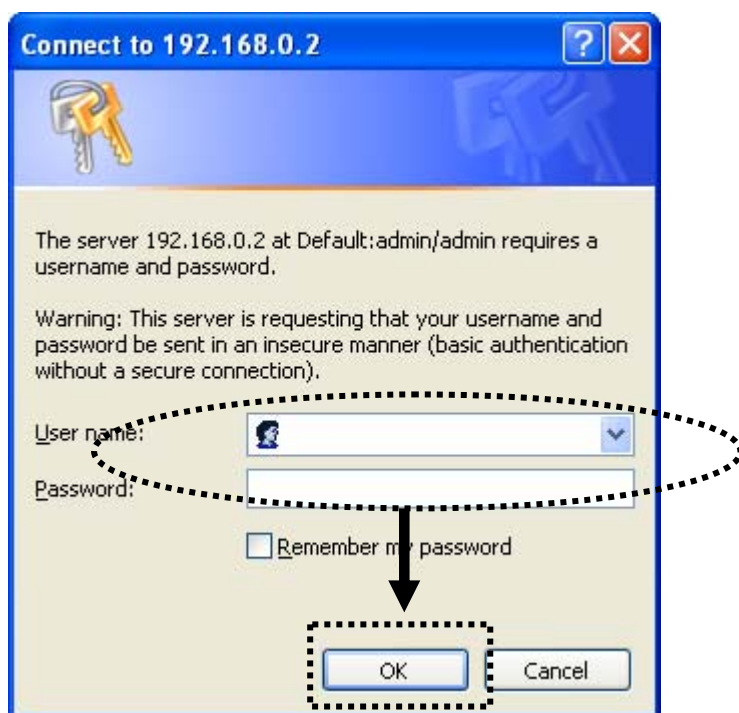

Detailed operation instructions will be given below.

3-2-3 Home

The following information provides an overview of the client mode's status and network configuration.

To access the 'Home' menu, click 'Home' on the left.

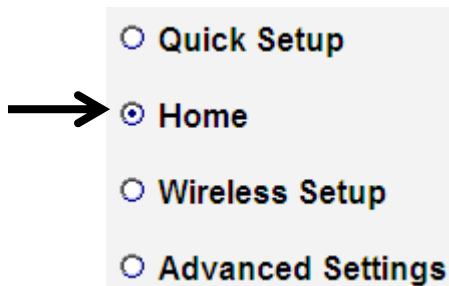

You should see the screen that looks like this (the contents will vary depending on your actual settings):

System	
Uptime	0day:0h:0m:36s
Hardware Version	Rev. A
Runtime Code Version	1.05
Wireless Configuration	
Mode	Station-Infrastructure
ESSID	Winchester
Channel Number	4
Security	WEP
BSSID(MAC)	80:1F:02:41:CC:3A
State	Connected
LAN Configuration	
IP Address	192.168.0.2
Subnet Mask	255.255.255.0
Default Gateway	
MAC Address	80:1F:02:41:CC:3A

3-2-4 Wireless Setup – SSID

To access the ‘SSID’ page, click ‘Wireless Setup’ on the left, and then click ‘SSID’.

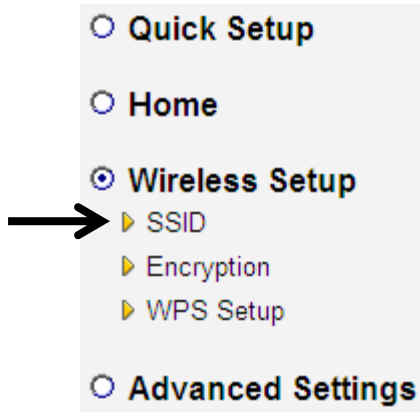

Basic Settings

SSID stands for Service Set Identifier. All stations must be configured with the correct SSID to access the Wireless Network.

Band :	2.4 GHz (B+G+N) ▼
MAIN ESSID :	Winchester
Site Survey :	Select Site Survey

- Enable LED OFF mode
- Turn off all LED
 - Turn off all LED except POWER LED

Apply Cancel

The description of every setup item is listed here:

Item	Description
Band	Select the band you want to use; all the wireless clients must follow the same setting to connect to this repeater.
MAIN ESSID	This is the name of the wireless network for this Wireless-N Range Extender.
Select Site Survey	Click the ‘Select Site Survey’ button to choose a new Root AP.

Enable LED off mode

You can enable or disable LED lights.
Check '**Enable LED OFF**' mode to setup LED behavior:
Turn off all LED: disables all LED lights

Turn off all LED except the POWER LED: all LED lights will be disabled, except the 'POWER' LED

3-2-5 Wireless Setup – Encryption

To access the ‘Encryption’ page, click ‘Wireless Setup’ on the left, and then click ‘Encryption’.

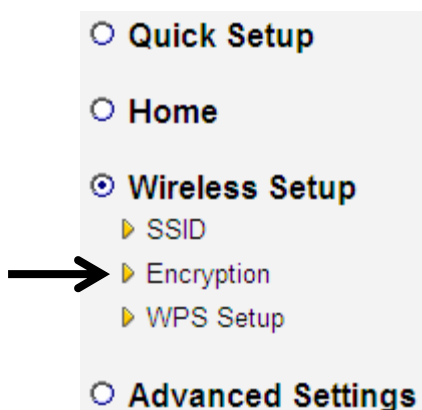

Security

This page allows you to specify whether a network key is used for authentication to the wireless network. If network authentication is set to Disabled, then no authentication is provided.

Encryption :

Select the security type of the wireless link:

Encryption: Disable (no security), WEP, WPA pre-shared key, or WPA RADIUS and click the ‘APPLY’ button.

NOTE: For WPS2.0 compliance specification, WEP and WPA-PSK encryption cannot support WPS connection; some wireless devices may follow this latest WPS2.0 specification, so we recommend using WPA2-PSK Encryption or (Network Authentication Open – WEP Encryption Disabled) to avoid interoperability problems.

WEP encryption: Select key length (64 or 128bit), key format (Hex or ASCII characters), Default Tx Key (by default ‘Key 1’), and input key characters (refer to ‘Key Format’ you selected for number of characters)

WPA pre-shared key: Select one WPA Unicast Cipher Suite (it is recommended to use default setting ‘WPA(TKIP)’), Pre-shared Key Format: Passphrase (alphanumeric characters) or Hex (64 Hex Characters), and input the key characters in the ‘KEY’ field.

3-2-6 Wireless Setup - WPS Setup

This page allows you to change the WPS settings (Wi-Fi Protected Setup). WPS allows your wireless clients to connect automatically to the Access Point.

To access the 'WPS Setup' click the 'Wireless Setup' menu on the left, then click 'WPS Setup'.

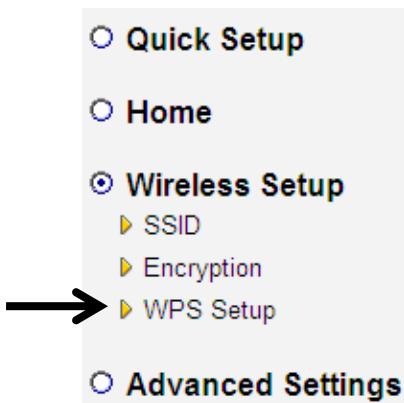

The following setup page will appear:

WPS(Wi-Fi Protected Setup) Settings

This page allows you to change the WPS settings (Wi-Fi Protected Setup). WPS allows your wireless clients to connect automatically to the Access Point.

Enable WPS

- **Wi-Fi Protected Setup Information**

WPS Status:	Unconfigured
Self PinCode:	78665545
SSID:	Comtrend
Authentication Mode:	Disable
Passphrase Key:	

- **Device Configure**

(Device is be a Client) Config Mode:	Enrollee
Configure via Push Button:	<input type="button" value="Start PBC"/>
Input PIN code to AP/Router :	78665545 <input type="button" value="Start PIN"/>

The description of every setup item is listed here:

Item	Description
WPS Status	If the wireless security (encryption) function of this Wireless-N Range Extender is properly set, the WPS Status will display 'Configured'. If wireless security function has not been set, the WPS Status will display 'unConfigured'.
Self PinCode	This displays an 8-digit number for WPS PIN-style configuration. When other WPS-compatible devices wish to connect to this Wireless-N Range Extender and support Self-PIN type WPS, input this number to the wireless device to establish connection.
SSID	SSID stands for Service Set Identifier. All stations must be configured with the correct SSID to access the Wireless Network.
Authentication Mode	Shows the authentication mode of this Wireless-N Range Extender.
Passphrase Key	This shows asterisks (*) to indicate wireless security is properly set.

Config Mode	Client mode only supports 'Enrollee' mode, you can input this client mode's PIN code to the AP/Router.
Start PBC	<p>Click the 'Start PBC' button to start the Push-Button style WPS setup procedure. This Wireless-N Range Extender will wait for WPS requests from another wireless device for 2 minutes.</p> <p>The 'WPS' LED on the Wireless-N Range Extender will be blinking for 2 minutes when this Wireless-N Range Extender is waiting for an incoming WPS request.</p>
Start PIN	<p>Click the 'Start PIN' button and input this PIN code to the wireless broadband router or Access point you wish to connect to.</p> <p>The 'WPS' LED on the Wireless-N Range Extender will be blinking when this Wireless-N Range Extender is waiting for an incoming WPS request.</p>

3-2-7 Advanced Settings

To access the ‘Advanced Settings’ menu, click ‘Advanced Settings’ on the left.

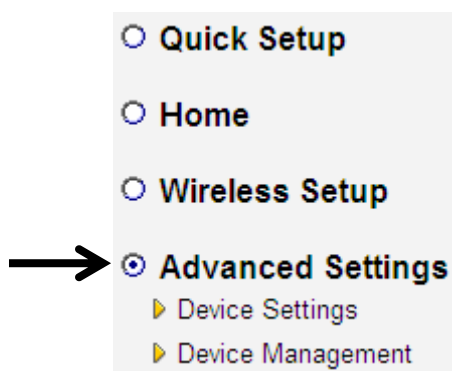

The following setup page will appear:

Fragment Threshold:	<input type="text" value="2346"/>	(256-2346)
RTS Threshold:	<input type="text" value="2347"/>	(0-2347)
Channel Width:	<input checked="" type="radio"/> Auto 20/40 MHz	<input type="radio"/> 20 MHz
WMM:	<input type="radio"/> Enable	<input checked="" type="radio"/> Disable
TX Power:	<input type="text" value="100 %"/>	▼

- Enable LED OFF mode
 - Turn off all LED
 - Turn off all LED except POWER LED

The description of every setup item is listed here:

Item	Description
Fragment Threshold	The threshold (number of bytes) of the fragmentation boundary for directed messages. It is the maximum data fragment size that can be sent. Input a value between 256 and 2346.

RTS Threshold	The RTS (Request To Send) threshold parameter controls what size data packet (number of bytes) the low level RF protocol issues to an RTS packet. The default is 2347.
Channel Width	Select the wireless channel width, 20MHz or 40MHz. 40MHz provides better network speed for 802.11n wireless clients. However, if there are 802.11b / g clients connecting to this Wireless-N Range Extender, it will switch to 20MHz mode automatically.
WMM	Enable or disable Wireless Multi-Media. When enabled, the Wireless-N Range Extender will give priority to multimedia related network applications for better performance.
TX Power	Select the wireless transmitting power level, from 10% to 100%. When wireless clients are not too far from this Wireless-N Range Extender, you don't have to select a higher power level, since this may cause some individuals to attempt to break into your wireless network if you have a bad password, or no password.
Enable LED off mode	You can enable or disable LED lights. Check ' Enable LED OFF ' mode to setup LED behavior: Turn off all LED: disables all LED lights Turn off all LED except the POWER LED: all LED lights will be disabled, except the 'POWER' LED

When you finish the settings in this page, click the 'Apply' button. You'll see the following message:

Save settings successfully!

You may press CONTINUE button to continue configuring other settings or press APPLY button to restart the system to make the changes take effect.



If you still need to configure this Wireless-N Range Extender, click the 'CONTINUE' button; if you want to save changes and use it now, click the 'APPLY' button.

System Restarting!

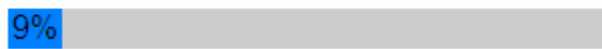

You'll be prompted to wait for 30 seconds before you can reconnect to the Web user interface of this Wireless-N Range Extender.

3-2-8 System Utility

You can change the settings of several system-level parameters in this page, including the administrator's password, and IP address.

To access the 'System Utility' menu, click 'Device Settings' on the left.

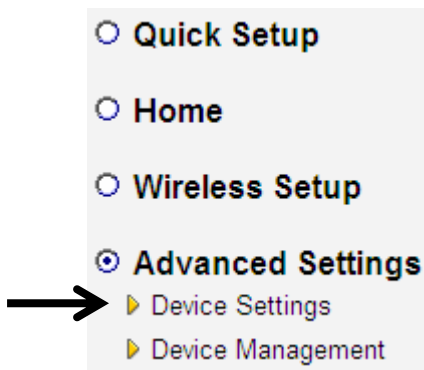

The following setup page will appear:

- **Password Settings**

Current Password :	<input type="text"/>
New Password :	<input type="text"/>
Re-Enter Password :	<input type="text"/>

- **Management IP**

IP Address :	<input type="text" value="192.168.0.2"/>
Subnet Mask :	<input type="text" value="255.255.255.0"/>
Gateway Address :	<input type="text"/>

The description of every setup item is listed here:

Password Settings

The default password of this Wireless-N Range Extender is admin, and it's displayed on the login prompt when accessed from the web browser. There's a security risk if you don't change the default password, since everyone can see it. This is very important when you have the wireless function enabled.

Here are descriptions of every setup item:

Item	Description
Current Password	To change the password, you have to input the current password first.
New Password	Input the new password here. You can use a combination of letters, numbers, and symbols for up to 20 characters.
Re-Enter Password	Input the new password again for conformation.

Management IP

To set up the IP address of this Wireless-N Range Extender, please see the following description.

Item	Description
IP Address	<p>Input the IP address of the LAN / Wi-Fi port of the Wireless-N Range Extender.</p> <p><i>NOTE: Please remember this IP address. If you forget this IP address and you didn't use the DHCP server function to assign IP address to clients, you won't be able to connect to this Wireless-N Range Extender and you'll need to clear all settings and password to reset the IP address back to the default value '192.168.0.2' on Client mode.(Press the WPS button and hold for 10 seconds to restore all settings to factory defaults)</i></p>
Subnet Mask	Input the subnet mask of the IP address you're using.
Gateway Address	Input the gateway's IP address of your network. Generally you can use '0.0.0.0' (default value) since this Wireless-N Range Extender will access the Internet via the WAN port.

When you finish the settings in this page, click the 'Apply' button. You'll see the following message:

Save settings successfully!

You may press CONTINUE button to continue configuring other settings or press APPLY button to restart the system to make the changes take effect.



If you still need to configure this Wireless-N Range Extender, click the 'CONTINUE' button; if you want to save the changes and use it now, click the 'APPLY' button. You'll be prompted to wait for 30 seconds before you can reconnect to Web user interface of this Wireless-N Range Extender.

3-2-9 Configuration

You can backup and restore the configuration of this Wireless-N Range Extender, so you can recall all the settings without the need to reconfigure again.

This function is especially useful when you need to use this Wireless-N Range Extender in different places, like your home and a hotel.

To access the 'Configuration' menu, click 'Device Management' on the left.

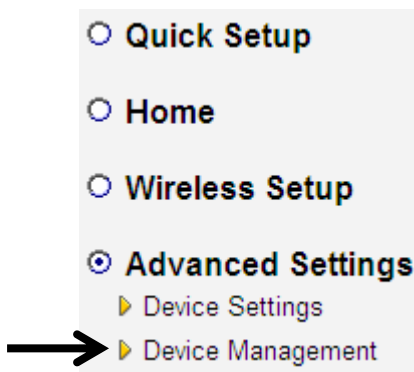

Configuration Tool

The following setup page will appear:

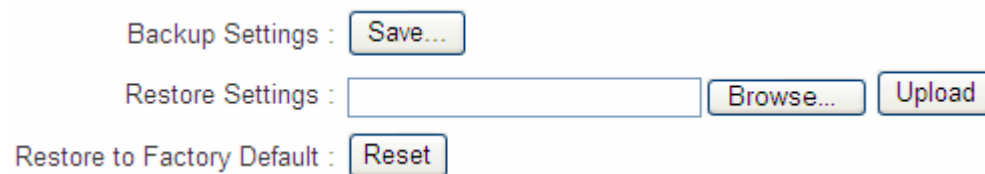

The description of every setup item is listed below:

Item	Description
Backup Settings	<p>Use the "Backup Settings" option to save the Wireless-N Range Extender's current configuration settings to a local file on your computer. It will be named "config.bin." Click the 'Save' button to save the current settings to a file on your computer. You can then use the "Restore Settings" option to restore the saved configuration to the Wireless-N Range Extender if it is reset or loses its configuration.</p>
Restore Settings	<p>If you want to upload a saved configuration file to the Wireless-N Range Extender, please click the 'Browse' button to select a saved configuration file on your computer. Then click the 'Upload' button to restore the current settings to the new one.</p>
Reset to Factory Default	<p>To reset all settings of this Wireless-N Range Extender to factory defaults, including the password. You'll be prompted to confirm the settings reset:</p> <div data-bbox="497 1128 1351 1469" data-label="Image"> <p>The image shows a standard Windows-style dialog box. The title bar reads "Message from webpage" and has a close button (X) on the right. The main area contains a question mark icon followed by the text "Do you really want to reset the current settings to default?". At the bottom, there are two buttons: "OK" and "Cancel".</p> </div> <p>Click the 'OK' button if you really want to restore all settings, or click 'Cancel' to abort.</p>

WEB Upgrade

The software running in this Wireless-N Range Extender (i.e. ‘Firmware’) can be upgraded to improve the functionality of this Wireless-N Range Extender.

It is recommended that you upgrade the firmware from a wired computer. Enter the path and name of the upgrade file and then click the APPLY button below.

You can access our website to look for the latest firmware file. Then download the latest firmware file and save on your computer and upload to this Wireless-N Range Extender.

WEB Upgrade

It is recommended that you upgrade the firmware from a wired computer. Enter the path and name of the upgrade file and then click the APPLY button below.

The description of every setup item is listed here:

Item	Description
Browse	Select a firmware file saved on your computer.

When you are ready, click the ‘Apply’ button to start the firmware upgrade procedure.

Reset

In the event that the system stops responding correctly or stops functioning, you can perform a standard Reset or Reset to Defaults. A standard Reset will retain your settings and reboot the Wireless-N Range Extender, while resetting the device to defaults will erase all configuration settings.

When you think this Wireless-N Range Extender is not working properly, resetting it may help.

Reset

In the event that the system stops responding correctly or stops functioning, you can perform a standard Reset or Reset to Defaults. A standard Reset will retain your settings and reboot the device, while resetting the device to defaults will erase all configuration settings.

APPLY

To reset this Wireless-N Range Extender, click the 'Apply' button. You'll be prompted to confirm the reset:

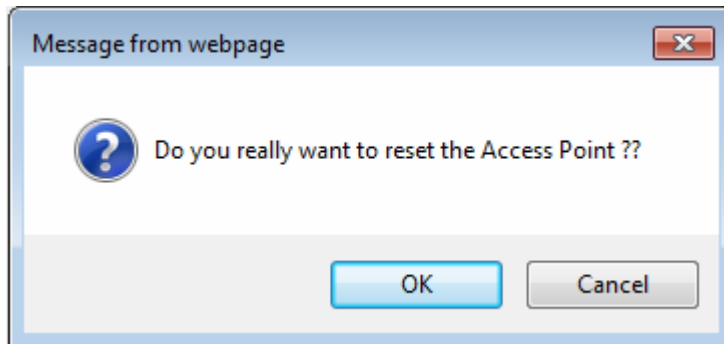

Click the 'OK' button to reset the Wireless-N Range Extender, or click 'Cancel' to abort.

CHAPTER IV: AP Mode

You can setup a wireless networking environment for your home or small office. Switch this Wireless-N Range Extender to wireless (AP) access point mode and connect it to your wired router. Then your wireless client users can access the Internet by wirelessly connecting to this AP without the burden of wired cabling.

This chapter will explain how to quickly install this Wireless-N Range Extender by using quick setup and introduce the detailed settings on the web user interface page of AP mode.

4-1 AP Mode Quick Installation Guide

Switch mode selector to '**AP**'.

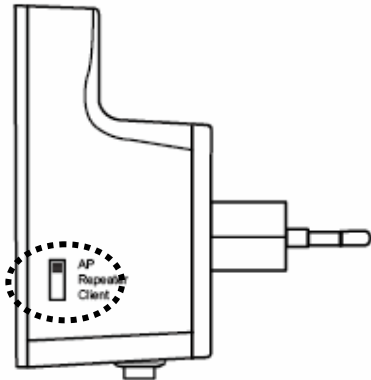

Plug this Wireless-N Range Extender into a power outlet on the wall, and flip the power switch to '**ON**' (1). You should see the '**Power**' LED light up in a few seconds (2). If not, check if the power outlet you're using is working.

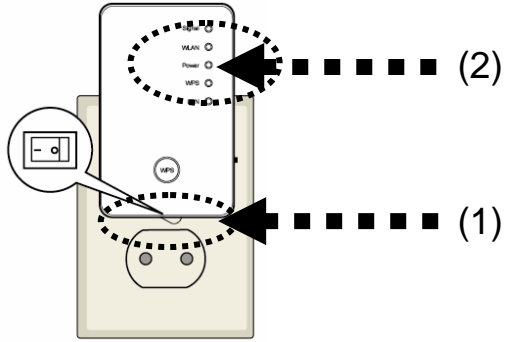

You can setup a wireless connection via the 'Hardware WPS button' or 'Software web browser'.

If your wireless client also supports a 'WPS button', we recommend that you use the WPS button to establish connection.

Using WPS button

- please go to section 4-1-1

Using Web browser

- please go to section 4-1-2

4-1-1 Hardware WPS button setup

(1) Press the **WPS button twice** on the Wireless-N Range Extender, the ‘WPS’ LED will start flashing.

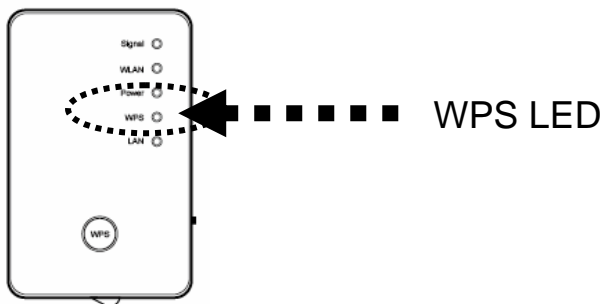
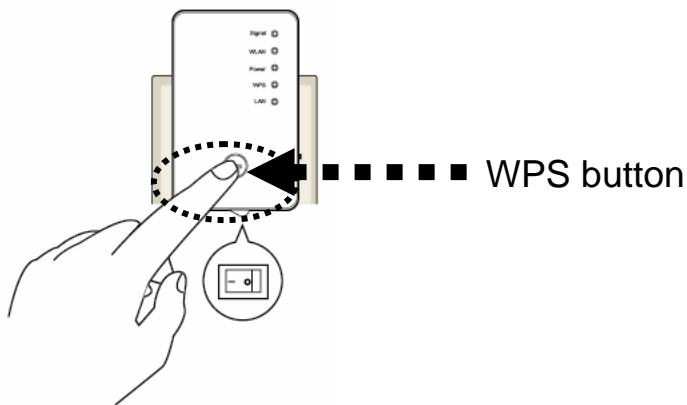

(2) Press the **WPS button** on the wireless client you wish to connect to within 2 minutes.

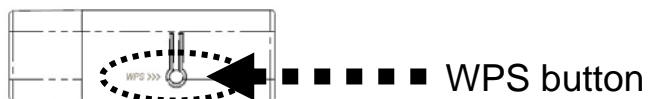

NOTE: the WPS button position on client card is for reference, different devices may have different WPS button positions or locations.

TIP: If your wireless client card does not have a hardware WPS button, you can also use its web configuration menu's WPS function to establish connection. Or you can login to this repeater's web user interface to complete the quick setup (detailed setup refers to section '4-1-2 Web browser quick setup')

(3) If the WPS connection is successful, the '**WPS**' LED will stay lit for 5 minutes; if the '**WPS**' LED flashes fast, a problem has occurred, please wait for 2 minutes until the '**WPS**' LED is off, and start from step(1) again.

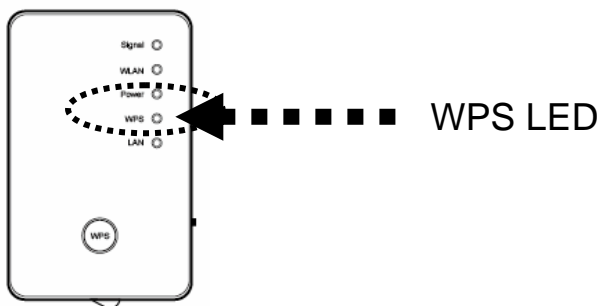

When quick installation is successful, the '**Signal**' LED will turn on.

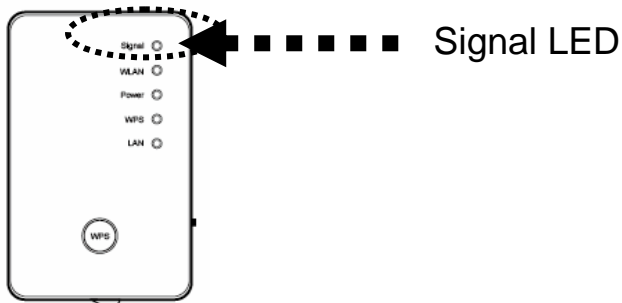

(4) When the '**Signal**' LED displays a Steady light the wireless signal is optimal.

(5) Connect this access point to an ADSL modem, wired router, or switch/hub in your network through the LAN port of the access point by Ethernet cable.

The quick installation setup is complete, you can refer to section '4-2 AP mode Advanced Settings' to login in to the web user interface for other advanced settings.

4-1-2 Web browser quick setup

Before you can connect to the Wireless-N Range Extender and start configuration procedures, your computer must be able to get an IP address automatically (use dynamic IP address). If it's set to use a static IP address, or you're unsure, please refer to '[Chapter V: Appendix, 5-1 Configuring TCP/IP on PC](#)' to set your computer to use a dynamic IP address.

(1) Use an Ethernet cable to connect your computer's Ethernet port and the Wireless-N Range Extender's Ethernet port.

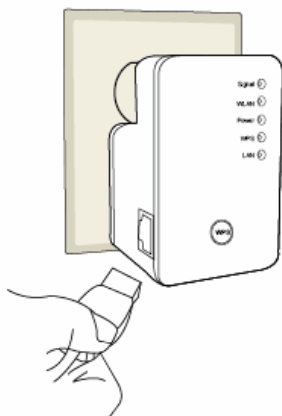

Or use your computer's wireless configuration utility to search for an access point named '**comtrend**' and get connected. (The default SSID of this Wireless-N Range Extender is 'comtrend')



(2) Open your web browser and input '**http:// 192.168.0.2**' in the address bar.

***NOTE:** By default the Comtrend WAP-5883 has a default IP address of 192.168.0.2. To login through the Web Management interface, your computer (whether connected wirelessly or via Ethernet directly to the Wireless-N Range Extender) will need to have an IP in the same range: 192.168.0.x. (where x equals any number between 3 and 254). If your network has a different IP range, set your computer to a static IP to configure this Wireless-N Range Extender for the first time and set it to match your network settings.*

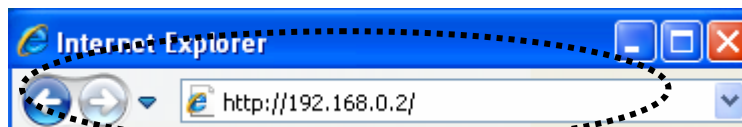

(3) The Wireless-N Range Extender will prompt you to input the username and password. The default username is '**admin**' and the password is '**admin**'. Click the 'OK' button to continue.

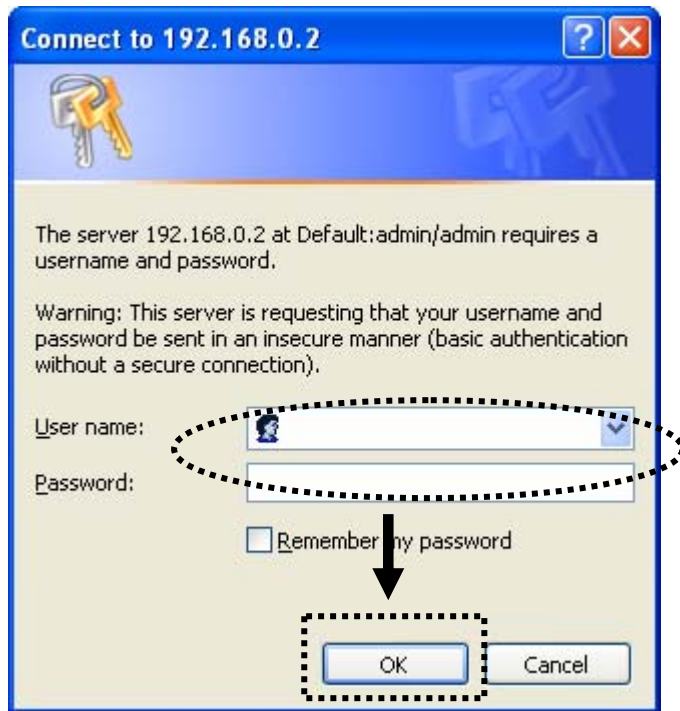

(4) Please input the SSID (a name used to identify this access point) in the 'Device SSID' field, and then click the 'Next' button. The default SSID is **comtrend**, you can change this default SSID if you want.



This page allows you to specify whether a network key is used for authentication to the wireless network.

Security

Please input the wireless encryption key needed to connect to your Access Point or Wireless Router

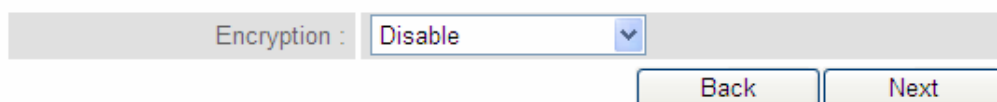

(5) Select the security type of the wireless link:
Encryption: Disable (no security), WEP, WPA pre-shared key, or WPA RADIUS and click the 'Next' button.

Note:

WEP encryption: Select key length (64 or 128bit), key format (Hex or ASCII characters), Default Tx Key (by default 'Key 1'), and input key characters (refer to 'Key Format' you selected for number of characters)

WPA pre-shared key: Select one WPA Unicast Cipher Suite (it is recommended to use default setting 'WPA(TKIP)'), Pre-shared Key Format: Passphrase (alphanumeric characters) or Hex (64 Hex Characters), and input the key characters in 'KEY' field.

WPA RADIUS: Only use this option if you have a RADIUS authentication server on your LAN. You have to input the RADIUS server's parameters (Server IP, port number, and password).

(6) Recheck the settings you made, and click the 'Apply' button to continue.

Save settings successfully!

Please press APPLY button to restart the system to make the changes take effect.

device SSID : **Comtrend**

Security : **Disable**



(7) Please wait for a few moments for the Wireless-N Range Extender to restart.

System Restarting!



(8) After the reboot is complete, the web browser will login to the access point's home page of the Web user interface. You can close the browser to finish this quick setup and connect this access point to the ADSL modem, wired router, or switch/hub in your network through the LAN port of the access point by Ethernet cable.

NOTE: After quick installation is complete and you want to login to the Web UI of the repeater, please refer to section '5-2 AP mode Advanced Settings' for more functions or learn how to login the web user interface again.

4-2 AP mode Advanced Settings

4-2-1 Setup IP address

The default IP address of this Wireless-N Range Extender in AP mode is **192.168.0.2**, please make sure that your PC's IP is within the range of 192.168.0.3~192.168.0.254.

Before you can login to the web user interface, you need to set your computer's IP address to any IP within this subnet. If you don't know how to do this, please refer to following instructions.

Windows XP IP address setup:

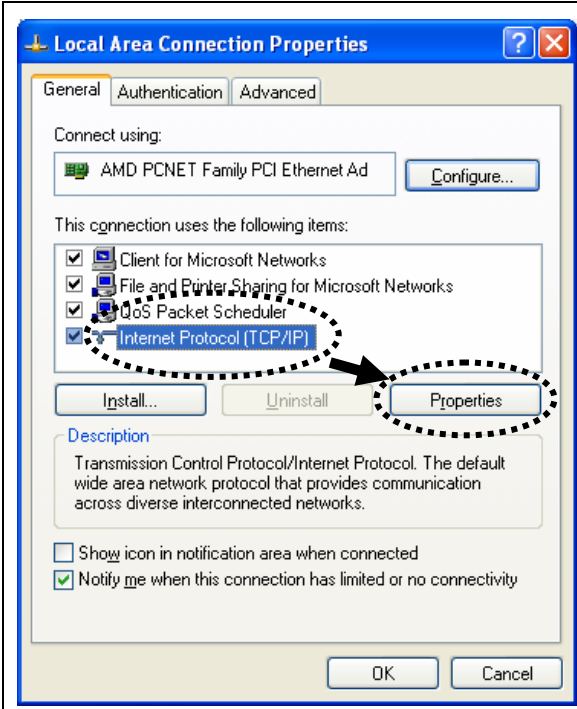

The screenshot shows the 'Local Area Connection Properties' dialog box in Windows XP. The 'General' tab is selected. Under 'Connect using:', 'AMD PCNET Family PCI Ethernet Ad' is listed. Below, 'This connection uses the following items:' lists several checked items: 'Client for Microsoft Networks', 'File and Printer Sharing for Microsoft Networks', 'QoS Packet Scheduler', and 'Internet Protocol (TCP/IP)'. A dashed oval highlights the 'Internet Protocol (TCP/IP)' item, with an arrow pointing to the 'Properties' button located below the list. The 'Description' section at the bottom provides details about the Transmission Control Protocol/Internet Protocol. At the bottom of the dialog are 'OK' and 'Cancel' buttons.

Click the 'Start' button (it should be located at the lower-left corner of your computer screen), then click control panel. Double-click the **Network and Internet Connections** icon, and then click **Network Connections**, double-click **Local Area Connection**, the **Local Area Connection Status** window will appear, and then click the 'Properties' button.

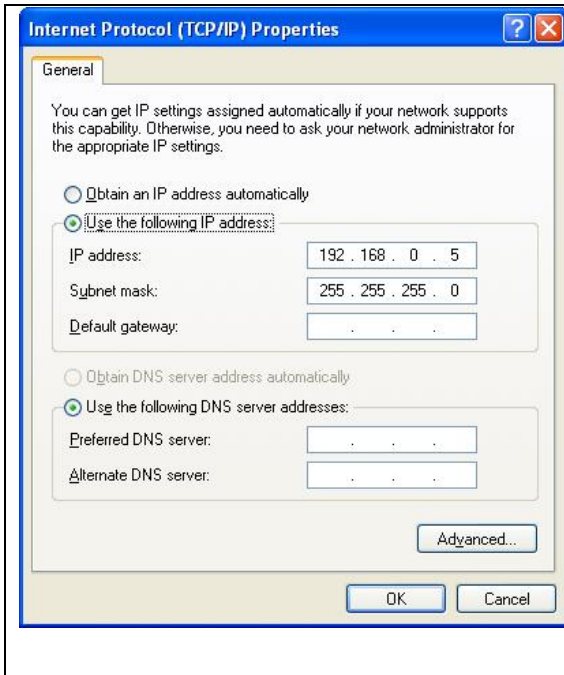

Select 'Use the following IP address', then input the following settings in their respective fields:

IP address: 192.168.0.x (where x is an integer greater than 2 or less than 254, if there's more than one computer that needs to use this Wireless-N Range Extender on the same network, every computer should use a unique number)
 Subnet Mask: 255.255.255.0
 Click the 'OK' button when finished.

Windows Vista/7 IP address setup:

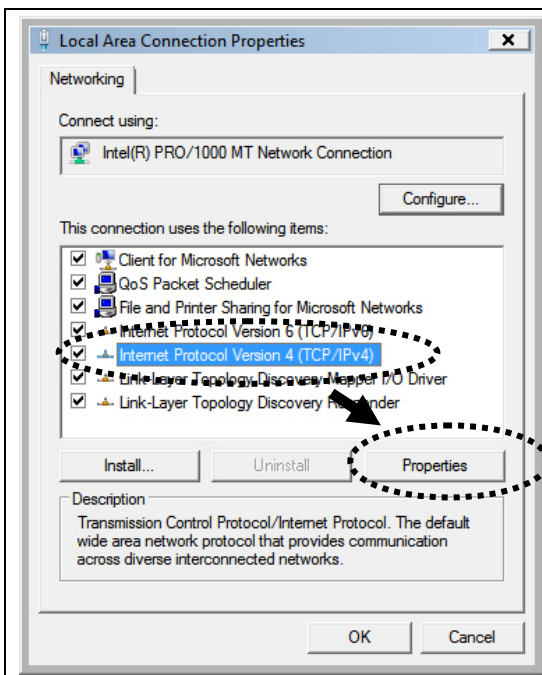

Click the 'Start' button (it should be located at the lower-left corner of your computer screen), then click the control panel. Click **View Network Status and Tasks**, then click **Manage Network Connections**. Right-click **Local Area Network**, then select **'Properties'**. The **Local Area Connection Properties** window will appear, select 'Internet Protocol Version 4 (TCP / IPv4)', and then click 'Properties'

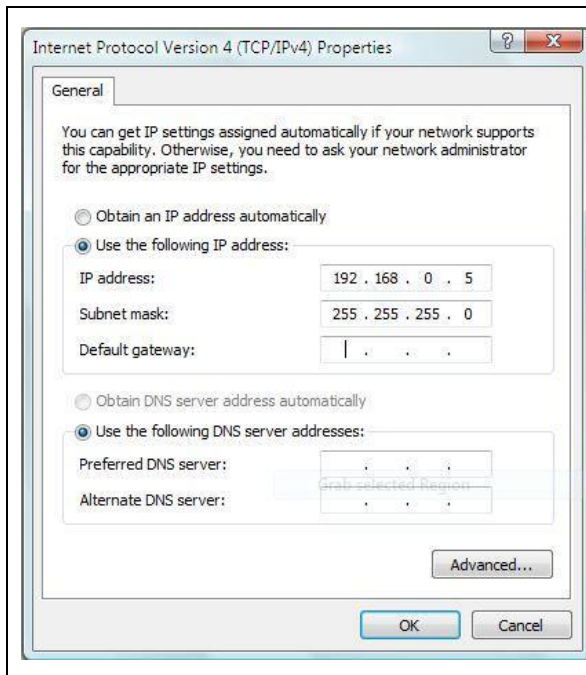

Select 'Use the following IP address', then input the following settings in their respective fields:

IP address: 192.168.0.x (where x is an integer greater than 2 or less than 254, if there's more than one computer that needs to use this Wireless-N Range Extender on the same network, every computer should use a unique number)
Subnet Mask: 255.255.255.0
Click 'OK' when finished.

4-2-2 Connect to web configuration menu

Open your web browser (IE, Firefox, Chrome etc.) and input **192.168.0.2** in the address bar then press the ENTER key:

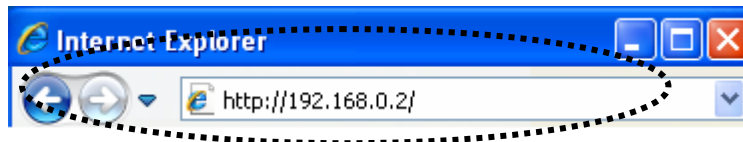

The Wireless-N Range Extender will prompt you to input the username and password. The default username is '**admin**' and the password is '**admin**'. Click the 'OK' button to continue.

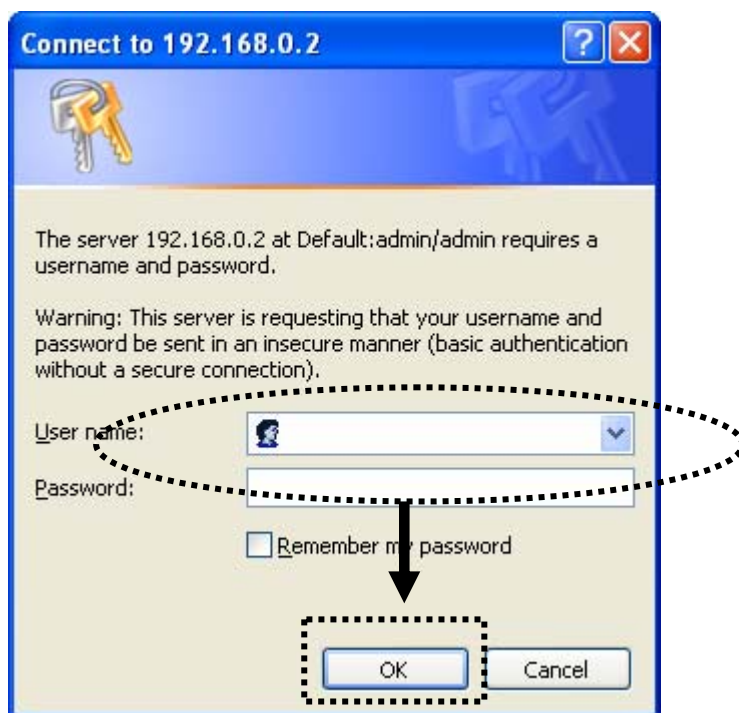

You should be able to see the configuration screen of this Access Point mode in a short time:

Detailed operation instructions will be given below.

4-2-3 Home

The following information provides an overview of the access point's status and network configuration.

To access the 'Home' menu, click 'Home' on the left.

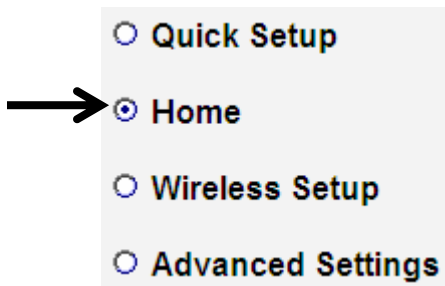

You should see a screen that looks like this (the contents will vary depending on your actual settings):

System	
Uptime	0day:0h:0m:37s
Hardware Version	Rev. A
Runtime Code Version	1.05
Wireless Configuration	
Mode	AP
ESSID	Comtrend
Channel Number	auto
Security	Disable
BSSID(MAC)	80:1F:02:41:CC:3A
Associated Clients	0 <input type="button" value="Show Active Clients"/>
LAN Configuration	
IP Address	192.168.0.2
Subnet Mask	255.255.255.0
Default Gateway	
MAC Address	80:1F:02:41:CC:3A

You can click the 'Show Active Clients' button to show all connected wireless clients.

Please note: By clicking the 'Show Active Clients' button, a new browser window will appear. If your browser prevents pop-up windows from appearing, please disable this function or you will not be able to use the 'Show Client' function.

4-2-4 Wireless Setup – SSID

To access the ‘SSID’ page, click ‘Wireless Setup’ on the left, and then click ‘SSID’.



Basic Settings

SSID stands for Service Set Identifier. All stations must be configured with the correct SSID to access the Wireless Network.

Band :	2.4 GHz (B+G+N) ▼
MAIN ESSID :	Comtrend
Channel Number :	Auto ▼
Associated Clients :	Show Active Clients

- Enable LED OFF mode
- Turn off all LED
 - Turn off all LED except POWER LED

Apply Cancel

The description of every setup item is listed here:

Item	Description
Band	Select the band you want to use; all the wireless clients must follow the same setting to connect to this repeater.
MAIN ESSID	This is the name of the wireless network for this Wireless-N Range Extender.
Channel Number	This is the radio frequency used to transmit and receive the wireless signal. The wireless devices in the same network should follow the same channel setting.

Associated Clients	Click the ‘Show Active Clients’ button, and then an “Active Wireless Client Table” will pop up. You can see the status of all active wireless stations that are connected to the access point.
Enable LED off mode	<p>You can enable or disable LED lights. Check ‘Enable LED OFF’ mode to setup LED behavior:</p> <p>Turn off all LED: disables all LED lights</p> <p>Turn off all LED except the POWER LED: all LED lights will be disabled, except the ‘POWER’ LED</p>

4-2-5 Wireless Setup – Encryption

To access the 'Encryption' page, click 'Wireless Setup' on the left, and then click 'Encryption'.

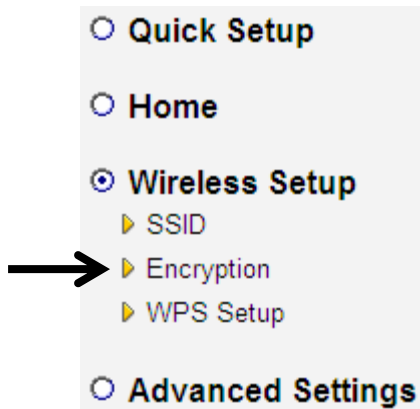

Security

This page allows you to specify whether a network key is used for authentication to the wireless network. If network authentication is set to Disabled, then no authentication is provided.

Encryption :

Select the security type of the wireless link:

Encryption: Disable (no security), WEP, WPA pre-shared key, or WPA RADIUS and click the 'APPLY' button.

WEP encryption: Select key length (64 or 128bit), key format (Hex or ASCII characters), Default Tx Key (by default 'Key 1'), and input key characters (refer to 'Key Format' you selected for number of characters)

WPA pre-shared key: Select one WPA Unicast Cipher Suite (it is recommended to use default setting 'WPA(TKIP)'), Pre-shared Key Format: Passphrase (alphanumeric characters) or Hex (64 Hex Characters), and input the key characters in the 'KEY' field.

WPA RADIUS: Only use this option if you have a RADIUS authentication server on your LAN. You have to input the RADIUS server's parameters (Server IP, port number, and password).

4-2-6 Wireless Setup - WPS Setup

This page allows you to change the WPS settings (Wi-Fi Protected Setup). WPS allows your wireless clients to connect automatically to the Access Point.

To access the 'WPS Settings' page, click 'Wireless Setup' on the left, and then click 'WPS Setup'.

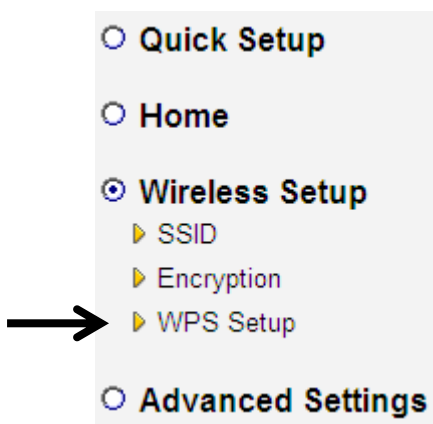

The following setup page will appear:

• Wi-Fi Protected Setup Information

WPS Status:	Configured
Self PinCode:	78665545
SSID:	Comtrend
Authentication Mode:	WEP
Passphrase Key:	

• Device Configure

Config Mode:	Registrar	▼
Configure via Push Button:	Start PBC	
Input client PIN code :	<input type="text"/>	Start PIN

The description of every setup item is listed here:

Item	Description
WPS Status	If the wireless security (encryption) function of this Wireless-N Range Extender is properly set, the WPS Status will display 'Configured'. If wireless security function has not been set, the WPS Status will display 'unConfigured'.
Self PinCode	This displays an 8-digit number for WPS PIN-style configuration. When other WPS-compatible devices wish to connect to this Wireless-N Range Extender and support Self-PIN type WPS, input this number to the wireless device to establish connection.
SSID	SSID stands for Service Set Identifier. All stations must be configured with the correct SSID to access the Wireless Network.
Authentication Mode	Shows the authentication mode of this Wireless-N Range Extender.
Passphrase Key	This shows asterisks (*) to indicate that the wireless security is properly set.
Config Mode	There are 'Registrar' and 'Enrollee' modes for the WPS connection. When 'Registrar' is enabled, the wireless clients will follow the access point's wireless settings for WPS connection. When 'Enrollee' mode is enabled, the access point will follow the wireless settings of the wireless router for WPS connection.
Start PBC	Click the 'Start PBC' button to start the Push-Button style WPS setup procedure. This Wireless-N Range Extender will wait for a WPS request from another wireless device for 2 minutes. The 'WPS' LED on the Wireless-N Range Extender will be blinking for 2 minutes when this Wireless-N Range Extender is waiting for an incoming WPS request.

Start PIN	<p>Click the 'Start PIN' button and input this PIN code to the wireless broadband router or Access point you wish to connect to.</p> <p>The 'WPS' LED on the Wireless-N Range Extender will be blinking when this Wireless-N Range Extender is waiting for an incoming WPS request.</p>
-----------	---

NOTE: For WPS2.0 compliance specification, WEP and WPA-PSK cannot support WPS connection, some of the wireless devices may follow this latest WPS2.0 specification, so we recommend not using WEP and WPA-PSK to avoid a WPS interoperability problem.

4-2-7 Advanced Settings

To access the 'Advanced Settings' menu, click 'Advanced Settings' on the left.

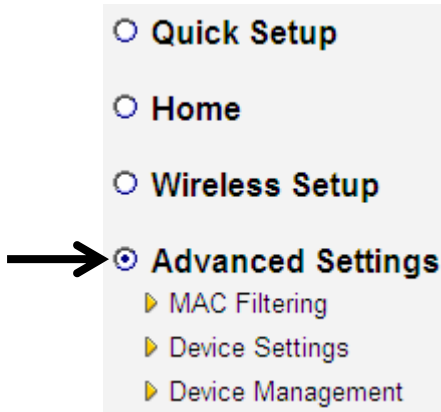

The following setup page will appear:

Fragment Threshold:	<input type="text" value="2346"/>	(256-2346)
RTS Threshold:	<input type="text" value="2347"/>	(0-2347)
Beacon Interval:	<input type="text" value="100"/>	(20- (20-1000 ms))
DTIM Period:	<input type="text" value="3"/>	(1-10)
Data Rate:	<input type="text" value="Auto"/>	
N Data Rate:	<input type="text" value="Auto"/>	
Channel Width:	<input checked="" type="radio"/> Auto 20/40 MHz	<input type="radio"/> 20 MHz
Preamble Type:	<input checked="" type="radio"/> Short Preamble	<input type="radio"/> Long Preamble
Broadcast ESSID:	<input checked="" type="radio"/> Enable	<input type="radio"/> Disable
WMM:	<input type="radio"/> Enable	<input checked="" type="radio"/> Disable
CTS Protect:	<input checked="" type="radio"/> Auto	<input type="radio"/> Always <input type="radio"/> None
TX Power:	<input type="text" value="100 %"/>	
Channel Number:	<input type="text" value="4"/>	

Enable LED OFF mode

- Turn off all LED
- Turn off all LED except POWER LED

The description of every setup item is listed here:

Item	Description
Fragment Threshold	The threshold (number of bytes) of the fragmentation boundary for directed messages. It is the maximum data fragment size that can be sent. Input a value between 256 and 2346.
RTS Threshold	The RTS (Request To Send) threshold parameter controls what size data packet (number of bytes) the low level RF protocol issues to an RTS packet. The default is 2347.
Beacon Interval	The Beacon Interval value indicates the frequency interval of the beacon. Enter a value between 20 and 1000. A beacon is a packet broadcast by the Router to synchronize the wireless network. The default value is 100.
DTIM Period	Configures DTIM (Delivery Traffic Indication Message) send period. The default value is 3.
Data Rate	Select wireless data transfer speed. When you select a value here, this Wireless-N Range Extender will refuse to establish connection with wireless clients by other speeds. It's recommended to select 'Auto' and this Wireless-N Range Extender will adjust the speed automatically.
N Data Rate	Select wireless data transfer speed (MCS0 to MCS15). MCS stands for Modulation and Coding Scheme, which represents different speeds when the bandwidth is 20MHz or 40MHz. It's recommended to select 'Auto' and this Wireless-N Range Extender will adjust the speed automatically.
Channel Width	Select the wireless channel width, 20MHz or 40MHz. 40MHz provides better network speed for 802.11n wireless clients.

	<p>However, if there are 802.11b / g clients connecting to this Wireless-N Range Extender, it will switch to 20MHz mode automatically.</p>
Preamble Type	<p>The Preamble type defines the length of the CRC (Cyclic Redundancy Check) block for communication between the Access Point and roaming wireless adapters.</p> <p>Do not modify the default value if you don't know what it is, default setting is 'Short Preamble'.</p>
Broadcast ESSID	<p>When set to 'enabled', every wireless device can scan and find this Wireless-N Range Extender; when set to 'disabled', only wireless clients who know the exact SSID can get connected with this Wireless-N Range Extender. Setting to disabled will help to improve security.</p>
WMM	<p>Enable or disable Wireless Multi-Media. When enabled, the Wireless-N Range Extender will give priority to multimedia related network applications for better performance.</p>
CTS Protect	<p>This function provides CTS (Clear to Send) protection when transferring data. Selecting 'Auto' for this option is recommended.</p>
TX Power	<p>Select the wireless transmitting power level, from 10% to 100%. When wireless clients are not too far from this Wireless-N Range Extender, you don't have to select a higher power level, since this may cause some individuals to attempt to break into your wireless network if you have a bad password, or no password.</p>
Channel Number	<p>This is the radio frequency used to transmit and receive the wireless signal. The wireless devices in the same network should follow the same channel setting.</p>
Enable LED off mode	<p>You can enable or disable LED lights.</p> <p>Check 'Enable LED OFF' mode to setup LED behavior:</p> <p>Turn off all LED: disables all LED lights</p>

	Turn off all LED except the POWER LED: all LED lights will be disabled, except the 'POWER' LED
--	--

When you finish the settings in this page, click the 'Apply' button. You'll see the following message:

Save settings successfully!

You may press CONTINUE button to continue configuring other settings or press APPLY button to restart the system to make the changes take effect.



If you still need to configure this Wireless-N Range Extender, click the 'CONTINUE' button; if you want to save changes and use it now, click the 'APPLY' button.

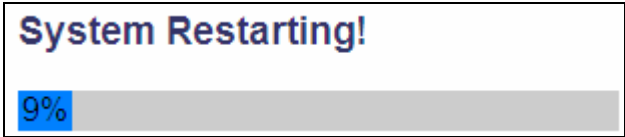

You'll be prompted to wait for 30 seconds before you can reconnect to the Web user interface of this access point.

4-2-8 MAC Address Filtering

For security reasons, the Comtrend WAP-5883 supports MAC Address Filtering, which only allows authorized MAC Addresses to associate with the Wireless-N Range Extender. Up to 20 entries can be configured.

This will enhance security because you can make a ‘white list’ allowing users in the list to use this Wireless-N Range Extender only in advance. Clients who aren’t listed on this white list can’t get connected, even if they know the password.

To access the ‘MAC Filtering’ menu, click ‘MAC Filtering’ on the left.

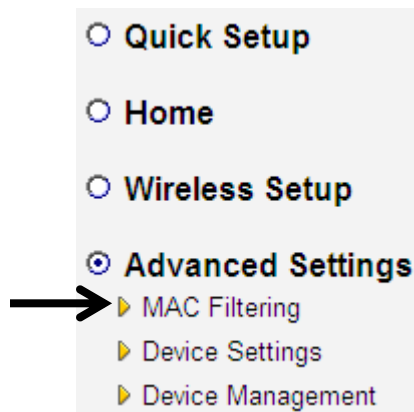

The following setup page will appear:

MAC Address Filtering

For security reasons, the Comtrend WAP-5883 supports MAC Address Filtering, which allows only authorized MAC Addresses to associate with the device. Up to 20 entries can be configured below.

- **MAC Address Filtering Table**

NO.	MAC Address	Comment	Select
<input type="button" value="Delete Selected"/> <input type="button" value="Delete All"/> <input type="button" value="Reset"/>			

Enable Wireless Access Control

New	MAC Address:	Comment:	<input type="button" value="Add"/>	<input type="button" value="Clear"/>
	<input type="text"/>	<input type="text"/>		

The description of every setup item is listed here:

Item	Description
Enable Wireless Access Control	Check this box to enable MAC filtering. If you don't check this box, anyone who knows the wireless password can get connected to this access point.
MAC Address	Input the MAC address of the clients you wish to deny or provide access to the Wireless-N Range Extender into the MAC address list. Input 12 HEX characters here, you don't have to add : (colon) or - (dash) characters every 2 characters. <i>If you don't know how to get the MAC address of a network client, see the following page.</i>
Comment	Input any descriptive text about this rule, so you can remember the purpose of this rule. Input up to 20 alphanumerical characters in this field.
Add	Add this MAC address to the list.
Clear	Clear 'MAC Address' and 'Comment' field.
Delete Selected	Delete the MAC address(es) whose 'Select' box you checked.

Delete All	Delete all MAC addresses in the list. You'll be prompted to confirm the deletion first.
Reset	Uncheck all checked boxes.

When you finish the settings in this page, click the 'Apply' button. You'll see the following message:

Save settings successfully!

You may press CONTINUE button to continue configuring other settings or press APPLY button to restart the system to make the changes take effect.



If you still need to configure this Wireless-N Range Extender, click the 'CONTINUE' button; if you want to save changes and use it now, click the 'APPLY' button. You'll be prompted to wait for 30 seconds before you can reconnect to this access point.

If you don't know the MAC address of your computer or wireless device, you can follow this procedure:

For wireless devices and computers that are connected to this Wireless-N Range Extender already, you can click the 'Show Active Clients' button on the 'Home' setting page.

Wireless Configuration	
Mode	Universal Repeater
ESSID	Winchester
Channel Number	4
Security	WEP
BSSID(MAC)	80:1F:02:41:CC:3A
Associated Clients	0 <input type="button" value="Show Active Clients"/>
State	Connected

Their MAC address will be displayed in the 'MAC Address' field.

If you still can't identify the MAC address of your computer, you can follow this procedure:

Click the network icon located at the lower-right corner, then click 'Open Network and Sharing Center'.

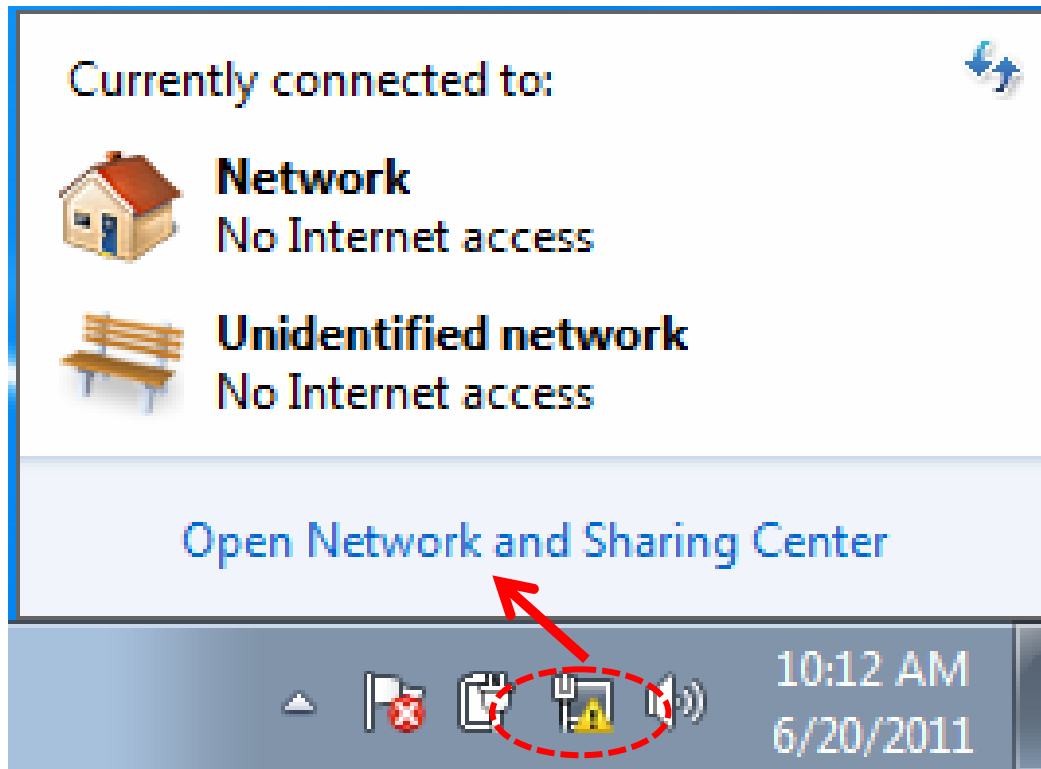

Click the connection that will be used to connect the wireless AP (in this example, 'Local Area Connection'):

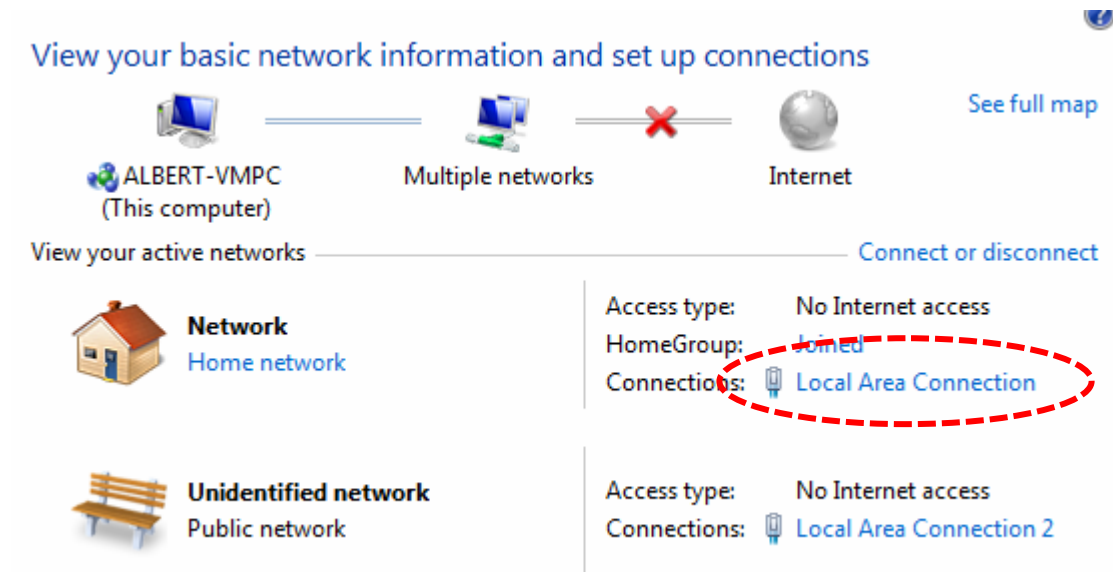

Click the 'Details...' button.

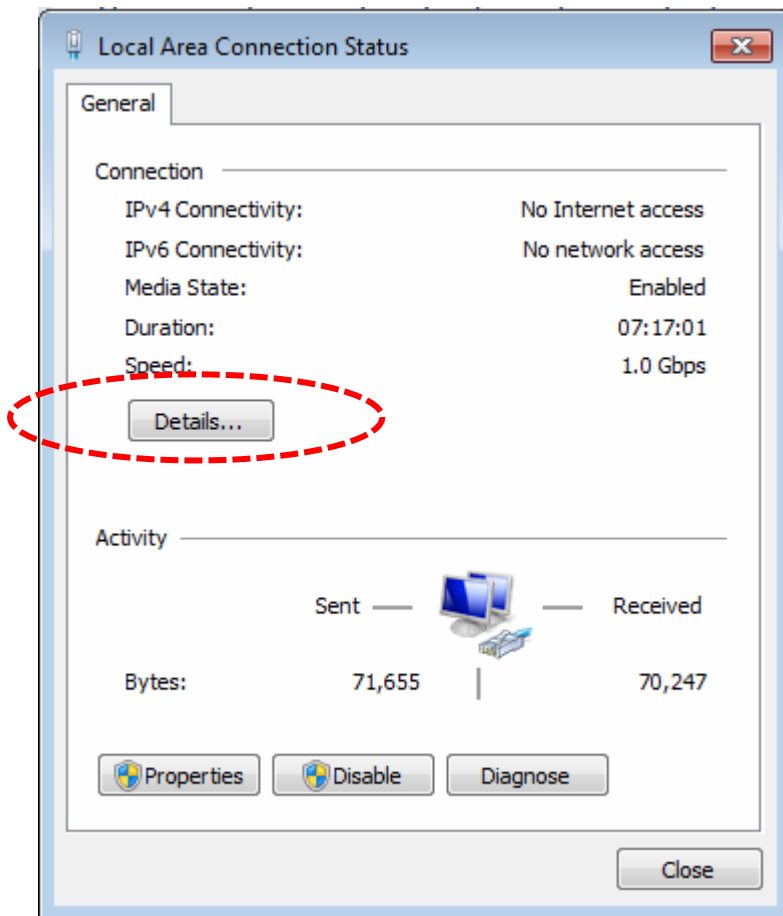

The MAC address of selected network connection will be displayed here as 'Physical Address'.

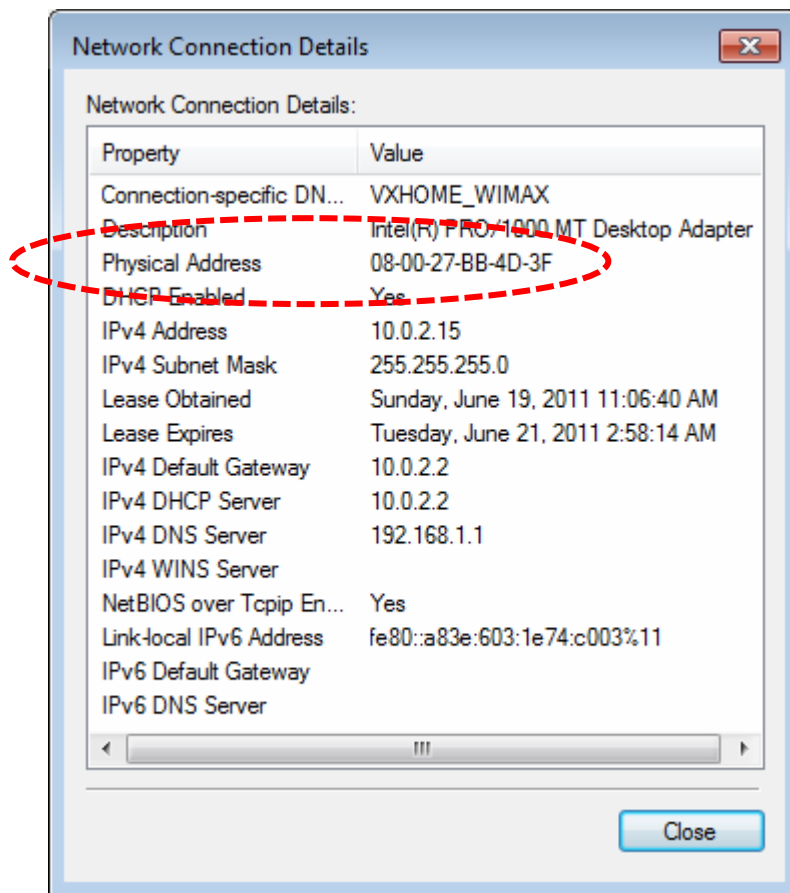

4-2-9 System Utility

You can change the settings of several system-level parameters in this page, including the administrator's password, and IP address.

To access the 'System Utility' menu, click 'Device Settings' on the left.

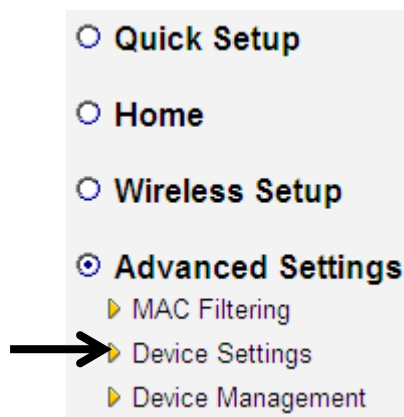

The following setup page will appear:

- **Password Settings**

Current Password :	<input type="text"/>
New Password :	<input type="text"/>
Re-Enter Password :	<input type="text"/>

- **Management IP**

IP Address :	<input type="text" value="192.168.0.2"/>
Subnet Mask :	<input type="text" value="255.255.255.0"/>
Gateway Address :	<input type="text"/>

- **DHCP Server**

DHCP Server :	<input type="text" value="Disabled"/>
Default Gateway IP :	<input type="text" value="192.168.0.2"/>
Domain Name Server IP :	<input type="text" value="0.0.0.0"/>
Start IP :	<input type="text" value="192.168.0.100"/>
End IP :	<input type="text" value="192.168.0.200"/>
Domain Name :	<input type="text" value="repeater.com"/>
Lease Time :	<input type="text" value="Forever"/>

The description of every setup item is listed here:

Password Settings

The default password of this Wireless-N Range Extender is “admin,” and it’s displayed on the login prompt when accessed from the web browser. There’s a security risk if you don’t change the default password, since everyone can see it. This is very important when you have the wireless function enabled.

Here are descriptions of every setup item:

Item	Description
Current Password	To change the password, you have to input the current password first.
New Password	Input the new password here. You can use a combination of letters, numbers, and symbols up to 20 characters.
Re-Enter Password	Input the new password again for conformation.

Management IP

To set up the IP address of this Wireless-N Range Extender, please see the following description.

Item	Description
IP Address	<p>Input the IP address of the LAN / Wi-Fi port of this access point.</p> <p><i>NOTE: Please remember this IP address. If you forget this IP address and you didn't use the DHCP server function to assign an IP address to clients, you won't be able to connect to this Wireless-N Range Extender and you'll need to clear all settings and password to reset the IP address back to the default value '192.168.0.2'. (Press the WPS button and hold for 10 seconds to restore all settings to factory defaults)</i></p>
Subnet Mask	<p>Input the subnet mask of the IP address you're using.</p>
Gateway Address	<p>Input the gateway's IP address of your network. Generally you can use '0.0.0.0' (default value) since this Wireless-N Range Extender will access the Internet via the WAN port.</p>

DHCP Server

This wireless access point is capable of acting as a DHCP server for your network, and it is disabled by default. If you want to activate this function, please select 'Enabled' in the 'DHCP Server' option, and see the following detailed instructions; if you don't want to use the DHCP server function of this wireless access point, or there's another DHCP server on the network this access point connects to, please select 'Disable'.

NOTE: If you select 'Disable' in the 'DHCP Server' option, all DHCP-related fields will be grayed out, and you will not be able to input any DHCP parameter.

Here are descriptions of every setup item:

Item	Description
Default Gateway IP	Input the IP address of the default gateway of your network here.
Domain Name Server IP	Input the IP address of the domain name server (DNS) here.
Start IP	Input the start IP address of the IP range.
End IP	Input the end IP address of the IP range.
Domain Name	If you wish, you can also optionally input the domain name for your network. This is optional.
Lease Time	Choose a lease time (the duration that every computer can keep a specific IP address) of every IP address assigned by this access point from the dropdown menu.

When you finish the settings in this page, click the ‘Apply’ button. You’ll see the following message:

Save settings successfully!

You may press CONTINUE button to continue configuring other settings or press APPLY button to restart the system to make the changes take effect.



If you still need to configure this Wireless-N Range Extender, click the ‘CONTINUE’ button; if you want to save changes and use it now, click the ‘APPLY’ button. You’ll be prompted to wait for 30 seconds before you can reconnect to this Wireless-N Range Extender.

4-2-10 Configuration

You can backup and restore the configuration of this access point, so you can recall all settings back without needing to configure again.

This function is especially useful when you need to use this Wi-Fi AP in different places, like your home and a hotel.

To access the 'Configuration' menu, click 'Device Management' on the left.

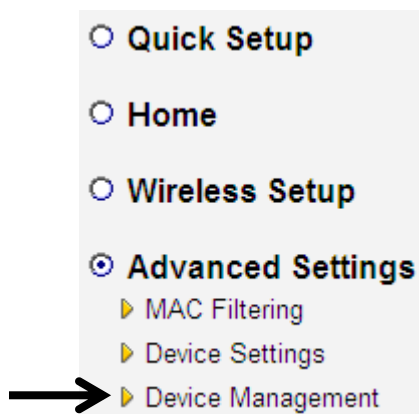

Configuration Tool

The following setup page will appear:

A screenshot of the Configuration Tool interface. It features three rows of controls. The first row is labeled 'Backup Settings' and has a 'Save...' button. The second row is labeled 'Restore Settings' and has a text input field, a 'Browse...' button, and an 'Upload' button. The third row is labeled 'Restore to Factory Default' and has a 'Reset' button.

The description of every setup item is listed here:

Item	Description
Backup Settings	Use the "Backup Settings" option to save the Wireless-N Range Extender 's current configuration settings to a local file on your computer. It will be named "config.bin." Click the 'Save' button to save the current settings to a file on your computer. You can then use the "Restore Settings" option to restore the saved configuration to the Wireless-N Range Extender if it is reset or loses its configuration.

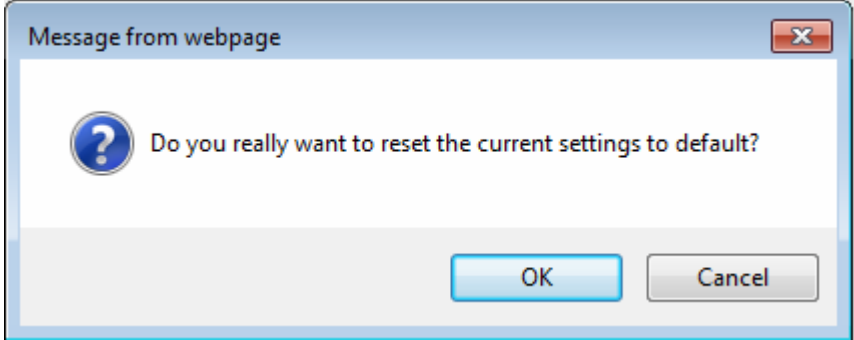
Restore Settings	<p>If you want to upload a saved configuration file to the Wireless-N Range Extender, please click the 'Browse' button to select a saved configuration file on your computer.</p> <p>Then click the 'Upload' button to restore the current settings to the new one.</p>
Reset to Factory Default	<p>To reset all settings of this Wireless-N Range Extender to factory defaults, including the password. You'll be prompted to confirm the settings reset:</p> <div data-bbox="497 696 1353 1034" style="border: 1px solid gray; padding: 10px; margin: 10px 0;">  </div> <p>Click the 'OK' button if you really want to restore all settings, or click 'Cancel' to abort.</p>

WEB Upgrade

The software running in this Wireless-N Range Extender (i.e. 'Firmware') can be upgraded to improve the functionality of this access point.

It is recommended that you upgrade the firmware from a wired computer. Enter the path and name of the upgrade file and then click the APPLY button below.

You can access our website to look for latest firmware file. Then download the latest firmware file and save on your computer and upload to this wireless AP.

WEB Upgrade

It is recommended that you upgrade the firmware from a wired computer. Enter the path and name of the upgrade file and then click the APPLY button below.

The description of every setup item is listed here:

Item	Description
Browse	Select a firmware file saved on your computer.

When you are ready, click the 'Apply' button to start the firmware upgrade procedure.

Reset

In the event that the system stops responding correctly or stops functioning, you can perform a standard Reset or Reset to Defaults. A standard Reset will retain your settings and reboot the Wireless-N Range Extender, while resetting the device to defaults will erase all configuration settings.

Reset

In the event that the system stops responding correctly or stops functioning, you can perform a standard Reset or Reset to Defaults. A standard Reset will retain your settings and reboot the device, while resetting the device to defaults will erase all configuration settings.

To reset this Wireless-N Range Extender, click the 'Apply' button. You'll be prompted to confirm the reset:

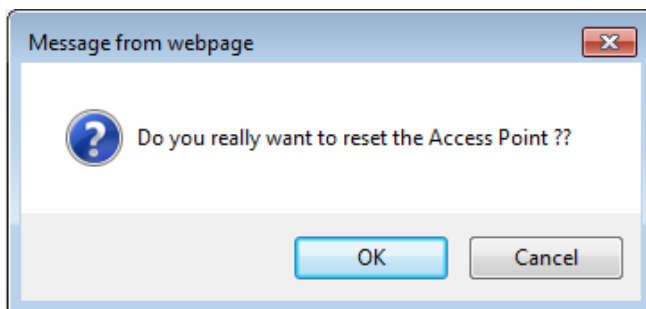

Click the 'OK' button to reset the Wireless-N Range Extender, or click 'Cancel' to abort.

Chapter V: Appendix

5-1 Configuring TCP/IP on PC

Windows XP IP address setup:

1. Click the 'Start' button (it should be located at the lower-left corner of your computer screen), then click control panel. Double-click *Network and Internet Connections* icon, and then click *Network Connections*, then double-click *Local Area Connection*, the *Local Area Connection Status* window will appear, and then click the 'Properties' button.

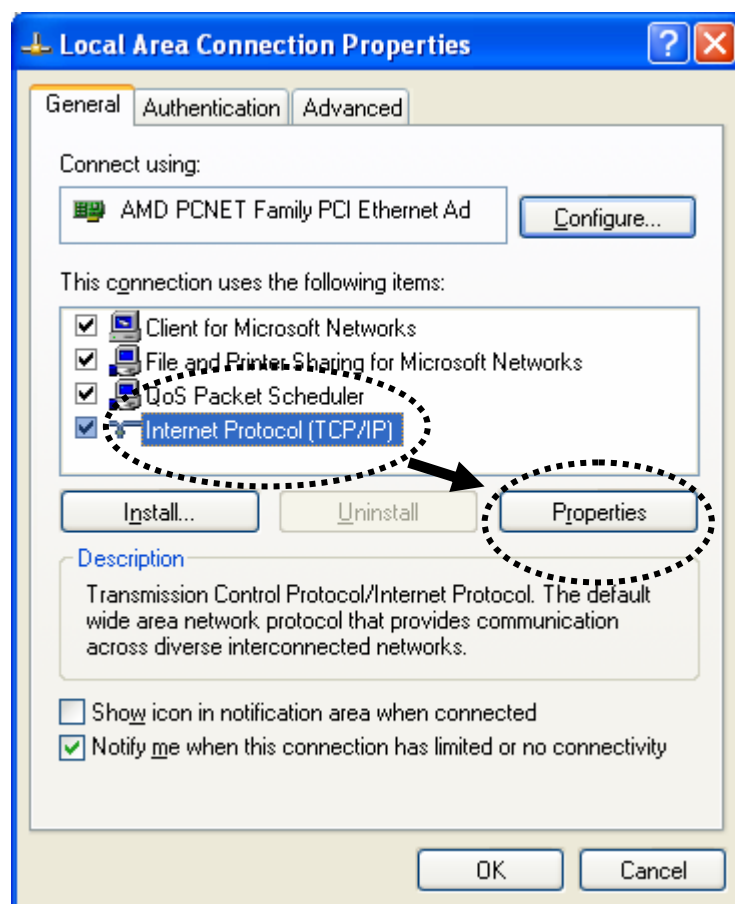

2. Select 'Obtain an IP address automatically' and 'Obtain DNS server address automatically', then click the 'OK' button.

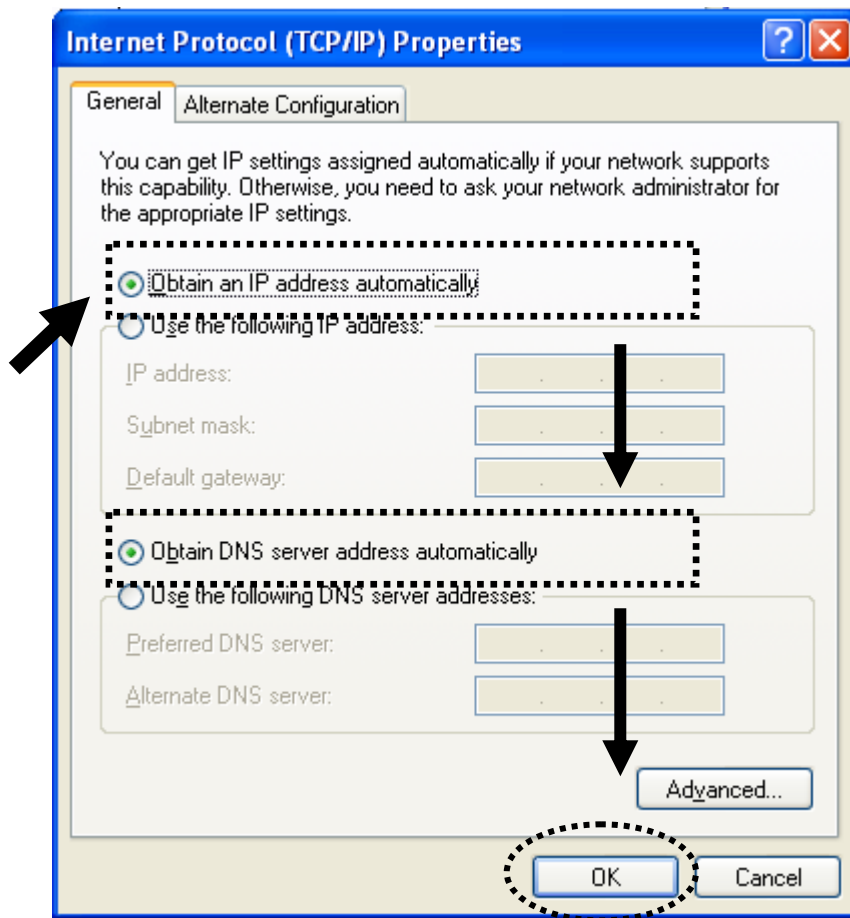

Windows Vista/Windows 7 IP address setup:

1. Click the 'Start' button (it should be located at lower-left corner of your computer screen), then click control panel. Click **View Network Status and Tasks**, and then click **Manage Network Connections**. Right-click **Local Area Network**, then select **'Properties'**. The **Local Area Connection Properties** window will appear, select 'Internet Protocol Version 4 (TCP / IPv4)', and then click the 'Properties' button.

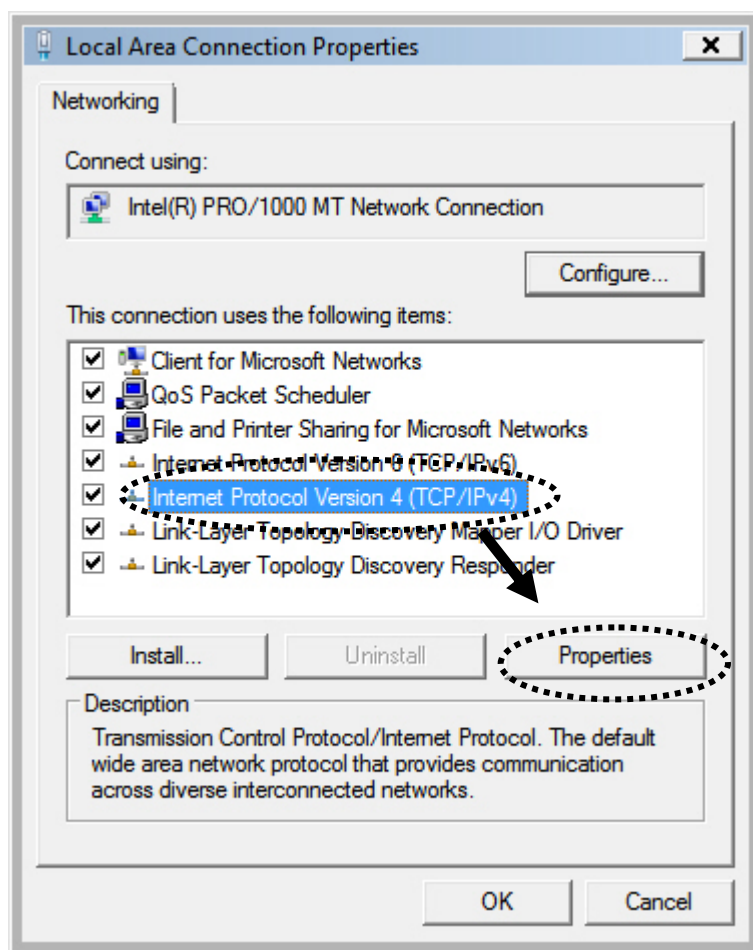

2. Select 'Obtain an IP address automatically' and 'Obtain DNS server address automatically', then click the 'OK' button.

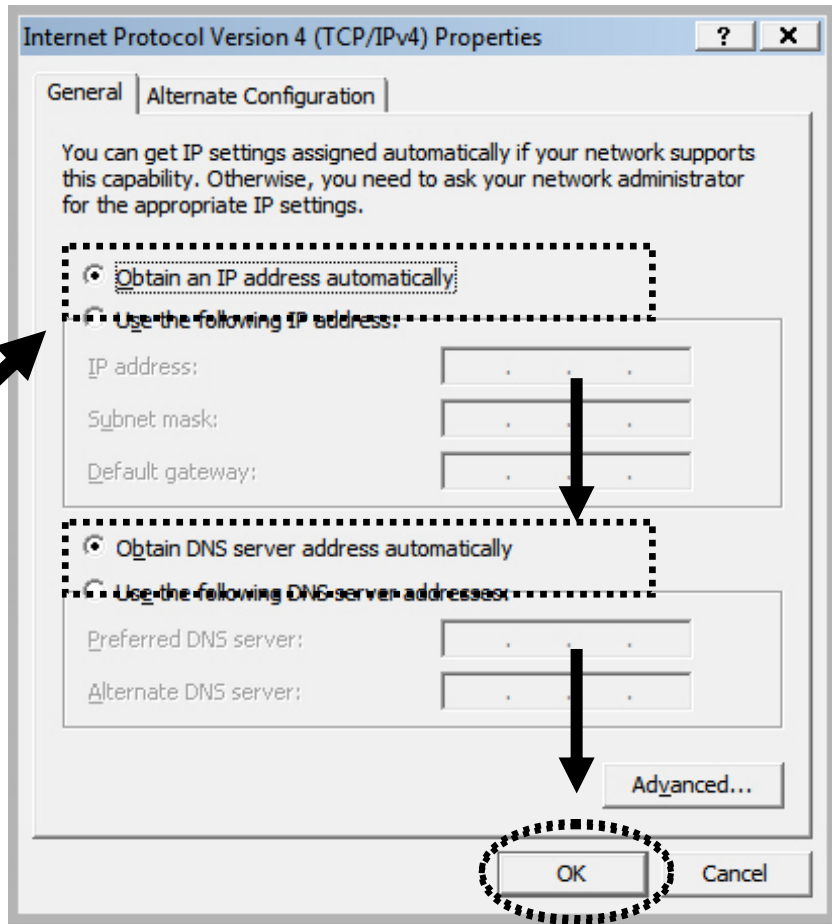

5-2 Specification

LAN Port: 10/100M UTP Port x 1

Power: 5VDC, 1A Switching Power Module Inside

Dimension: 46.5(W) x 73(H) x 41(D) mm excluding power plug

Transmit Power: 11n: 13dBm±1.5dBm, 11g: 14dBm±1.5dBm, 11b: 17dBm±1.5dBm

Temperature: 32~104°F (0 ~ 40°C)

Humidity: 10-90% (Non-Condensing)

Certification: FCC